



WESTERN SADDLE CLUBS ASSOCIATIONS, INC.

OFFICIAL RULEBOOK

in effect for the years
2013 • 2014 • 2015

24th Edition
Revised January 2013

www.wscsa.org

Table of Contents:

Contact Information:

* WSCA Officers, Directors & Others	1
* WSCA Committee Chairs	2
* WSCA Judges	3
* WSCA Member Clubs	5
* WSCA Mission Statement	10

General W.S.C.A. Information:

* History	9
* Scholarship Program	10
* Royalty Contest	10
* Information & Requirements for joining WSCA	11
* Eligibility for WSCA Championship Show	12
* WSCA Approved Show	12
* Recommendations for Show Committees	13
* WSCA Approved Judge	14
* WSCA Approved Safety Equipment	19

WSCA General Rules

* General Rules	15
* Explanation of Classes	
* Pleasure Classes	21
* Jumping Division	38
* Game Classes	42
* Drill & Square Dance	60

By-Laws of WSCA

63

General Horse Information

69

Index

84

Rulebook Changes

87

ANNUAL CHAMPIONSHIP HORSE SHOW

Eligibility requirements for this show are listed elsewhere in this Rulebook.

TROPHIES

RIBBONS

CASH AWARDS

HIGH POINT TROPHIES

**To the Saddle Club and individuals
with the most points in entire show.**

*The WSCA Queen will be crowned in
conjunction with the Championship Show.*

For further information on WSCA Inc. or on any item in the Rulebook, contact the Executive Secretary listed on page one (1).

Western Saddle Club Association, Inc. newsletter "SPOTLIGHT" which lists the upcoming show, news of saddle clubs, information to saddle clubs from WSCA etc. may be ordered from the SPOTLIGHT editor listed on page one (1). Each saddle club secretary will receive a monthly SPOTLIGHT. All news items, show dates, etc. should be sent directly from the saddle clubs to the SPOTLIGHT editor. Advertisements will be printed for a fee.

2013 WESTERN SADDLE CLUBS ASSOC. INC.

Officers/Key Personnel:

President:

Jerry Magin (12-13-14)

18036 Yorkshire Avenue
Prior Lake MN 55372
952-447-2525

Vice-President:

Keith Froemming (11-12-13)

17547 Major Avenue
Hutchinson MN 55350
320-587-8607

Treasurer:

Arlene Bayer

24452-403rd Avenue
Belgrade MN 56312
320-254-1509

Executive Secretary:

Teri Spence

47009 County Road 13
St. Peter MN 56082
507-345-5856
secretary@wsca.org

Qualifications Coordinator:

Evelyn Morehouse

3578 N Berens Road NW
Shakopee MN 55379
952-445-2019
qualifications@wsca.org

Championship Show Entries

Karen Whitaker

1420 State Highway 15
Fairmont MN 56031
952-238-1786

2013 WSCA Queen:

Caitlyn Gensch

1000 Valley Oaks
Vadnais Heights, MN 55127
651-206-2947

WSCA SPOTLIGHT Editor:

Randy Heuer

Herald Journal Publishing
120-6th Street N PO Box
Winsted MN 55395
320-485-2535 (metro)
SPOTLIGHT@wsca.org

BOARD OF DIRECTORS:

Kevin Berger (12-13-14)

9800 Union Hill Blvd
Belle Plaine MN 56011
952-873-6723

Robin Fauchald (11-12-13)

7524 Kadler Avenue NE
Monticello MN 55362
763-497-4582

Bill Freitag (13-14-15)

34503-250th Street
Henderson MN 56044
507-340-2647

Keith Froemming (11-12-13)

17547 Major Avenue
Hutchinson MN 55350
320-587-8607

Jerry Magin (12-13-14)

18036 Yorkshire Avenue
Prior Lake MN 55372
952-447-2525

Paul Miller (11-12-13)

6464 Oakwood Avenue NE
Elk River MN 55330
763-742-2146

Sherri Oswald (13-14-15)

9160 County Road 116
Corcoran MN 55340
763-420-2117

Ben Sparks (13-14-15)

20167-565th Avenue
Mankato MN 56001
507-625-6944

Glenn Strube (13-14-15)

6050 Quaas Avenue
Mayer MN 55360
952-657-2317

Tim Wampler (12-13-14)

40513 Lowden Avenue North
North Branch, MN 55056
715-497-6922

Karen Whitaker (11-12-13)

1420 State Highway 15
Fairmont MN 56031
507-238-1786

Logo by: Denise Griffin 1982

2013 WSCA COMMITTEE CHAIRPERSONS

Champ Show Committee:

Steve Tibbetts

6264 Ehler Avenue SE
Delano MN 55328
763-972-6544

Royalty Committee:

Bridget Behrns

23433-163rd Street NW
Big Lake MN 55309
612-325-4410

Drills & Squares:

Marlys Mooney

4805 Rebecca Park Trail
Loretto MN 55357
612-498-7469

Publicity Committee:

Cindy McClung

1726 County Road D
Emerald WI 54013
715-265-7153

Futurity Committee:

Shannon Williams

1461 Pinewood Drive
Woodbury MN 55125
651-214-1869
jmcranch@yahoo.com

Rulebook Committee:

Cindy Ladd

9055 Tiller Avenue
Young America MN 55397
952-583-0086
cando2020@aol.com

Judges Committee:

Sherri Oswald

9160 County Road 116
Corcoran MN 55340
763-420-2117

Safety Committee:

Bill Griep

24028 Germanium St. NW
St. Francis MN 55070
763-753-3454

Nominations Committee:

Bill Freitag

34503 - 250th Street
Henderson MN 56044
507-340-2647

Scholarship Comm.:

Kelly Nelson

230 Constance Blvd.
Andover MN 55304
763-434-5678

Parliamentarian:

John Gintner

14918-340th Street
Montgomery MN 56069
507-744-2561

Procedures Committee:

Sandy Strube

6050 Quaas Avenue
Mayer MN 55360
952-657-2317

A current roster of Board Members and Committee
Chairpersons are listed in the SPOTLIGHT
and on the WSCA Website <http://www.wsca.org>

2013 WSCA JUDGES

As new judges are added to the list, they will be listed in the WSCA SPOTLIGHT and WSCA website. The SPOTLIGHT may be obtained by contacting the SPOTLIGHT editor listed on page one of the WSCA Rulebook.

**New WSCA Judge*

***Bobzin, Steve**

6108 111 ½ Avenue N
Champlin, MN 55316
763-439-5307

Clark, Jim

11194 Dixon Road
Hibbing, MN 55746
218-262-2370

Crowley, Tim

146 Washington Street
Granite Falls, MN 56241
320-564-4036

Dahlby, Tamara

N6438 906th Street
Elk Mound, WI 54739
715-879-5654

Dexter, Malinda

14528 Knob Hill Road
Wadena, MN 56482
218-639-3361

Drevlow, Tessa

936 Van Buren Avenue SE
Bemidji, MN 56601
218-444-3956

Fauchald, Robin

7524 Kadler Avenue NE
Monticello, MN 55362
612-670-4128

Glasrud, Ann

970 Southern Pine Lane SW
Rochester, MN 55902
507-261-1686

Gunderson, Craig

1520 Wyndham Hill Drive
Hastings, MN 55033
612-810-4618

Gunderson, Lynn

1520 Wyndham Hill Drive
Hastings, MN 55033
612-810-4618

Gurtner, John

2022 12 1/2 Street
Cumberland, WI 54829
715-822-2732

Hagan-Kvanbeck, Linda

6150 225th Street E
Hampton, MN 55031
651-226-5718

Hartman, Allen

320 65th Avenue SE
Rochester, MN 55904
507-282-6834

Hoffmann, Ann Graney

8315 190th Street W
Lakeville, MN 55044
952-469-5993

Hottel, Lita

1766 10th Avenue SE
Rochester, MN 55904
507-830-0902

Jensen, Doug

30909 Knox Avenue
Redwood Falls, MN 56283
507-641-3333

Johnson, Ken

8655 Tellers Road
Chaska, MN 55318
952-443-2535

Johnson, Roy

13800 78th Place N
Maple Grove, MN 55311
763-274-3040

***Langness, Tina**

1593 160th Avenue
New Richmond, WI 54017
715-760-2496

Leonhart, Mary

12922 Irish Avenue N
Hugo, MN 55038
651-653-8576

Magin, Jerry

18036 Yorkshire Avenue
Prior Lake, MN 55372
952-447-2525

Meyer, Karen

837 Govern Circle
Eagan, MN 55123
651-994-7873

Murrell, Kari

1333 Roosevelt Street S
Cambridge, MN 55008
763-689-4053

***Nichols, Sherrie**

233 27th Street
New Auburn, WI 54757
715-237-2189

Ochs, Dick

19834 720th Avenue
Albert Lea, MN 56007
507-373-3861

Olson, Vonnie

N52960 County Road Y
Eleva, WI 54738
715-287-4223

Palmer-Visser, Teresa

9459 31st Street SE
Spiritwood, ND 58481
701-659-0173

Peterson, Bonnie

3363 County Road 139
Barnum, MN 55707
218-389-6671

Reeser, Denise

5526 North Killian Road
Brainerd, MN 56401
218-330-7355

Rieke, Alan

6566 France Avenue S #602
Edina, MN 55435
612-730-5310

Saterbak, Matthew

4200 Grimes Avenue N
Robbinsdale, MN 55422
763-350-3662

Saterbak, Michael

16930 150th Avenue
Foreston, MN 56330
763-639-0292

Shaw, Ken

236 8th Street
Tracy, MN 56175
507-629-4174

Sparks, Ben

20167 565th Avenue
Mankato, MN 56001
507-625-6944

Spidahl, Allan

15075 Homestead Avenue N
Hugo, MN 55038
651-429-5110

St. Martin, Lynn-Ellen

2746 14th Street NW
New Brighton, MN 55112
651-633-5044

Taylor, Dawn

P.O. Box 589
International Falls, MN 56649
807-274-7811

Tjosaas, Josh

3139 23rd Avenue SW, Unit B
Fargo, ND 58103
320-583-5056

Vetos, Val

29190 Bison Road NW
Princeton, MN 55371
763-389-3556

Whitfield, Pam

3862 Halling Place SW
Rochester, MN 55902
507-292-7833

Wood, Vee Ann

P.O. Box 6
Plato, MN 55370
320-238-2217

Ziegler, Kim

W15400 County Road F
Chetek, WI 54728
715-924-4866

WSCA MEMBER CLUBS

JANUARY 2013

A Little Bit Of Luck	Mayer, MN 55360
All Season Saddle Club	Brook Park, MN 55007
Anoka Saddle Club	Milaca, MN 56353
Arabian Horse Amateur Alliance	
Badgerland Barrel Racers	Roberts, WI 54023
Bit Of Blue Riders	Stillwater, MN 55082
Blue Ribbon Blitz	Waverly, MN 55390
Blue River Riders	Princeton, MN 55371
Blue Shadow Riders	Darwin, MN 55324
Bob's Saddle Club	Carver, MN 55315
Bootjack Saddle Club	Rogers, MN 55374
Cannon Valley Saddle Club	Dundas, MN 55021
Chances 'R' Saddle Club	Hamburg, MN 55339
Charging Knights Saddle Club	Sleepy Eye, MN 56085
Chatfield Saddle Club	Chatfield, MN 55923
Chequamegon E Z Riders	Iron River, WI 54847
Cherry Creek Riders Saddle Club	Le Sueur, MN 56058
Countryside Saddle Club	Willow River, MN 55795
Crazy Cowgirls Saddle Club	Big Lake, MN 55309
Crooked Tree Ranch	Medina, MN 55340
Dakota Ridge Riders	Hastings, MN 55033
Dalles Saddle Club	Amery, WI 54001
Dassel Outlaws & Misfits	
Dassel Saddle Club	Darwin, MN 55324
District 4 MQHA	Stacy, MN 55079
Dodge County Saddle Club	Dodge Center, MN 55927
Double Bit Riders Saddle Club	55092
Double S Saddle Club	Becker, MN 55308
Downsville Rough Riders Saddle Club	Menomonie, WI 54751
Dusty Road Riders Saddle Club	Cottage Grove, MN 55016
East Central Lopers Saddle Club	Mora, MN 55051
Eau Claire Bit - N - Spur	Eau Claire, WI 54703
Eden Prairie Horsemen	
Elk River Saddle Club	Fort Ripley, MN 56449
Elm Grove Saddle Club	Buffalo, MN 55313
Elmore Saddle Club	Stillwater, MN 55082
Fairmont Saddle Club	Granada, MN 56039
Flying D Saddle Club	Lakeville, MN 55044
Flying Lead Saddle Club	Virginia, MN 55792
Fox Hollow Saddle Club	Shakopee, MN 55379
Free Spirit Riders Saddle Club	South Range, WI 54874
Frieze Lake Ranch Saddle Club	
Glacial Ridge Appaloosa Horse Club	Spicer, MN 56288
Gopher Saddle Club	Delavan, MN 56023
Great Lakes Riders	
Happy Trail Riders Saddle Club	56379
Happy Trails Saddle Club	Hutchinson, MN 55350
Harmony Lite Riders Saddle Club	Racine, MN 55967
Hennepin Hoofbeats Saddle Club	Montrose, MN 55363
Horse 'N Around Saddle Club	Hanover, MN 55341
Horse Power Farm Saddle Club	Prior Lake, MN 55372
Indianhead Saddle Club	Chippewa Falls, WI 54729
Interstate Riders Saddle Club	Osceola, MN 54020
Island Riders Saddle Club	Pine Island, MN 55963
Itasca Sunset Saddle Club	55744
Kato Riders Saddle Club	Mankato, MN 56001
Kimball Saddle Club	Kimball, MN 55353
Kutt-A-Ways Saddle Club	Barnum, MN 55707
Lakes and Pines Saddle Club	Brainerd, MN 56401
Lakes Trail Blazers Saddle Club	Audubon, MN 56511
Lanoux Stables Saddle Club	
Le Sueur Saddle Club	New Ulm, MN 56073

Let Em Buck Saddle Club	Ortonville, MN 56278
Lindenruh Farm Saddle Club	Mayer, MN 55360
Little Crow Riders Saddle Club	Hutchinson, MN 55380
Little Mountain Wranglers	Monticello, MN 55362
Lucky Clovers Saddle Club	Hastings, MN 55033
Midstate North Star Saddle Club Saddle Club	Bethel, MN 55005
Minnesota Arabian Horse Association	Rosemount, MN 55068
Minnesota Palomino Horse Exhibitors	Prior Lake, MN 55372
Minnesota Pinto Horse Assoc. Sc	Corcoran, MN 55340
Minnesota Valley Riders Saddle Club	Le Sueur, MN 56058
MN Half Arabian Horse Assn.	Stacy, MN 55079
Mower County Trailblazers	Adams, MN 55909
Murray County Horse Association	Lismore, MN 56155
Nicollet County Sheriffs Posse	Courtland, MN 56021
Nicollet Raiders	Madison Lake, MN 56063
North Central Morgan Assoc.	Stillwater, MN 55082
Northeast Farms	Norwood, MN 55368
Northern Lights Saddle Club	International Falls, MN 56649
Northwest Saddle Club	White Bear, MN 55110
Northwest Wisconsin Equine Club	Stone Lake, WI 54876
Northwoods Saddle Club	Cook, MN 55723
Orchard Rangers Saddle Club	Prior Lake, MN 55372
Osakis Trailblazers Saddle Club	Belgrade, MN 56312
Over Easy Riders Saddle Club	Young America, MN 55397
Owatonna Saddle Club	Blooming Prairie, MN 55917
Pioneer Saddle Club	Loretto, MN 55357
Plainview Elgin Riders Saddle Club	Kellogg, MN 55945
Pony Pals	Cambridge, MN 55008
Prairie Wind Riders Saddle Club	Webster, MN 55088
Rainbow Saddle Club	Lakeville, MN 55044
Rambling Riders Saddle Club	Melrose, MN 56352
Ready 2 Run Saddle Club	New Prague, MN 56071
Red Barn Minnesota	Buffalo, MN 55313
Red Cedar Riders Saddle Club	Chetek, WI 54728
Reigning Riders Saddle Club	
Ricochet Riders Saddle Club	Maple Lake, MN 55358
Ridesport Stables Saddle Club	Eden Prairie, MN 55346
Riverbend Riders	Nicollet, MN 56074
Riverside Riders Saddle Club	Afton, MN 55001
Rochester Riders Saddle Club	Eyota, MN 55934
Rockin Red Riders Saddle Club	Montgomery, MN 56069
Rocky Riders Saddle Club	Eden Valley, MN 55329
Root River Saddle Club	Peterson, MN 55962
Ropin Around Saddle Club	Maple Plain, MN 55359
Round Up Riders Saddle Club	Milaca, MN 56353
Run Fast, Ride Hard Saddle Club	Litchfield, MN 55355
Rush River Renagades	Emerald, MN 54013
Saddle Bags	Onamia, MN 56359
Saddlelite Riders Saddle Club	St. Paul, MN 55107
Sand Creek Riders Saddle Club	New Prague, MN 56071
Sauk River Riders Saddle Club	Richmond, MN 56368
Scandia Riders Saddle Club	Centerville, MN 55038
Scattered About Saddle Club	Princeton, MN 55371
Scooten Rose Riders	Redwood Falls, MN 56283
Seven Mile Riders	St. Peter, MN 56082
Shamrock Hest Riding Club	56231
Silver Buckle Saddle Club	Plymouth, MN 55446
Silver Bullet Saddle Club	55320
Sky-Hi Riders Saddle Club	Stanchfield, MN 55080
Sleepy Eye Saddle Club	Sleepy Eye, MN 56085
Split Rail Saddle Club	Granite Falls, MN 56241
Spur Of The Moment Riders	Harris, MN 55032

Sterling Knoll Riders	Nicollet, MN 56074
Sunset Riders Saddle Club	Little Falls, MN 56345
Sunset Saddle Club	Owatonna, MN 55060
Switchin' Leads Saddle Club	Delano, MN 55328
Top Run Farm	Shakopee, MN 55379
Town & Country Saddle Club	Fergus Falls, MN 56537
Trail Dusters Of Hamel	Hamel, MN 55340
Trail Riders Saddle Club, Inc.	Oak Park Heights, MN 55082
Trailblazers Of Pepin	Alma, WI 54610
Trailblazers Saddle Club	Buffalo, MN 55313
Tri County Of Mankato	Mapleton, MN 56065
Tri-County Riders Of Watertown	Mayer, MN 55360
Triple B Saddle Club	Monticello, MN 55362
Triple H Saddle Club	Nicollet, MN 56074
Triple R Saddle Club	Spring Grove, MN 55974
United Barrel Racing Assoc.	Balsam Lake, WI 54810
Waldorf Colts Saddle Club	Mankato, MN 56001
Wanbapo Saddle Club	Robbinsdale, MN 55422
Waska Riders Saddle Club	Farwell, MN 56327
Western Mounted Paraders, Inc	Brownnton, MN 55312
Whisper Wood Riders Saddle Club	MILACA, MN 56353
Wild Bills Riders Saddle Club	Eau Claire, WI 54703
Wild River Riders Saddle Club	Wyoming, MN 55092
Wild Rivers Saddle Club	Danbury, WI 54830
Willow River Riders	Roberts, WI 54023
Wilton River Riders Saddle Club	Waseca, MN 56093
Windmill Ridge Riders	Menomonie, WI 54751
Windy Ridge Riders Horse Club	White Bear Lake, MN 55110
Wisconsin Northland Saddle Club	Luck, WI 54853
Wright Saddle Club	
Wurm Farms Saddle Club	Maple Lake, MN 55358

HISTORY

The Western Saddle Clubs Association Inc., (WSCA) was officially organized in 1955. Four (4) years earlier, when the new Coliseum opened, the Minnesota State Fair horse show had included Games and Drills and Square Dance competition for the first time. Saddle Clubs enthusiastically supported the new program. Fair management, astonished by the response, began working with Saddle Clubs to present only the best-qualified riders. At the same time, the Saddle Clubs recognized a need for uniform rules at open shows in the Upper Midwest. The mission statement of the new organization was to promote "the western-type horse" as well as to fulfill the needs mentioned above.

From an original roll call of twenty-one (21) clubs, the delegate controlled WSCA has grown to include more than two hundred fifty (250) clubs with well over fifteen thousand (15,000) individual memberships.

From the first meeting, WSCA promoted trail riding. Support for 4-H and other youth programs has been a constant part of the organization. In 1977, a scholarship program was added. Affordability and family involvement was in the forefront in 1955; those ideals remain intact today.

In 1959, the Championship Horse Show was born. From fourteen (14) classes on a Sunday afternoon in an outdoor arena, the show has grown to seventy (70) classes in four and a half (4-1/2) days at the Coliseum. Entries in 2006 numbered more than four thousand (4,000).

The first rulebook was published in 1958 under the direction of the Rules and Regulations Committee. Now as then, the rules, along with the goals and direction of the organization, are determined by the general delegation.

WSCA MISSION STATEMENT

To provide a safe and enjoyable experience to all participants of equestrian activities, to promote good horsemanship and sportsmanship skills and practices, to enrich members' experiences with their horses and also to promote the use of horses for personal and family enjoyment and competition.

SCHOLARSHIP PROGRAM

The Western Saddle Clubs Association (WSCA) administers an annual scholarship program that was initiated in 1977 in honor of Louie Klugman, a well-known Minnesota horseman and supporter of numerous horse-related activities. The program encourages and provides financial support for the continuing education of WSCA members beyond high school. It is a merit-based scholarship with applicants evaluated on scholarship, activities, and an essay relating educational and professional goals and how the scholarship would be used. All types of educational goals are acceptable. The funds can be used at four (4) year colleges, community colleges and vocational schools. A WSCA scholarship applicant must be a member in good standing of a WSCA saddle club. Application forms are available in the WSCA SPOTLIGHT and on the WSCA website (www.wsca.org) each year.

ROYALTY CONTEST

Each club may enter one (1) queen candidate to represent the club. The saddle club queen must have a shoulder banner and a crown. Their queen must be eighteen (18) years of age or older by January 1st of the current year and must be a member in good standing of a WSCA club. A color picture of their saddle club queen is a must for the program.

No person shall be eligible to compete in the contest if she has previously held the title of Ms. WSCA.

An application for the Royalty contest will be published in the SPOTLIGHT plus it is available on the WSCA website. A copy of the application can be ordered by mail from the WSCA Secretary or from the Royalty Committee Chairperson.

**INFORMATION AND REQUIREMENTS
FOR JOINING
WESTERN SADDLE CLUBS ASSOC., INC.
(WSCA)**

1. **Application for Membership:** Consists of names, address of current year's club officers, delegates and alternates. All clubs should hold elections by December so the Application for Membership forms may be completed and returned to the Executive Secretary post-marked not later than December 31st. These forms are vital in order to keep a current mailing list of member clubs to be used for notification of WSCA activities and sending the monthly SPOTLIGHT, etc. Application blanks are published in the SPOTLIGHT and listed under "Forms" page of the WSCA website. The Application for Membership forms and dues **MUST** be submitted not later than May 15th. No clubs may join or renew after that date.

2. **Dues:** Dues are sixty dollars (\$60.00) annually per club. Send application and dues to the WSCA Secretary **BEFORE** January 1st. **DEADLINE FOR DUES IS DECEMBER 31ST FOR THE NEXT YEAR.** For new clubs, dues are initially sixty-five dollars (\$65.00). After January 1st the cost for joining WSCA is increased accordingly: (Consult the table below).

Jan. 1 – Jan. 31	\$10.00 in addition to annual dues \$70.00 or \$75.00 new club
Feb. 1 – Feb. 29	\$20.00 in addition to annual dues \$80.00 or \$85.00 new club
Mar. 1 – Mar. 31	\$30.00 in addition to annual dues \$90.00 or \$95.00 new club
Apr 1 – Apr. 30	\$40.00 in addition to annual dues \$100.00 or \$105.00 new club
May 1 – May 15	\$50.00 in addition to annual dues \$110.00 or \$115.00 new club

3. **Membership List:** The list of saddle club paid members **MUST** be submitted online through the WSCA website. Required information is: Name – last and first, zip code and year of birth. Each individual must be entered separately, **NOT** as a family. A form with instructions and information on how to submit saddle club members to the online list can be found on the website "Forms" page.

This list is used to qualify your members' entries in the saddle club events at the Minnesota State Fair and the WSCA Championship Show. This is why we must have each member listed separately. The list is to be updated on the website **NO LATER THAN MAY 31st**. After this date, the late membership procedures must be followed. The WSCA Executive Secretary must be contacted for these late membership procedures.

4. The above requirements must be submitted by the stated deadlines. If your club is to be eligible to compete at the Saddle Club events at the Minnesota State Fair or the WSCA Championship Show. **Only those names on the club membership list that is submitted on line by May 31st or through the late membership process will be eligible for the State Fair events and the Championship Show.**

Each saddle club will receive a copy of the WSCA Rulebook. Rulebooks may be obtained from WSCA Rulebook Committee Chairperson.

The WSCA SPOTLIGHT "SPOTLIGHT" is sent twelve (12) months of the year to each saddle club secretary upon completion of item one (1) and two (2). Individual subscriptions to the SPOTLIGHT may be obtained through the SPOTLIGHT editor listed on page one of the WSCA Rulebook or page one of the SPOTLIGHT and/or the WSCA website.

Welcome to WSCA.

An individualized list of rulebook changes can be found on page 87 of the rulebook with page number of rule and highlighted within the rule book itself on said page.

ELIGIBILITY FOR WSCA CHAMPIONSHIP SHOW

Contestants must be members in good standing of a WSCA Inc. member saddle club. Horse and rider together must have placed first or second under a WSCA judge in their class during the current qualifying period (qualifying period begins thirteen (13) days prior to Labor Day and ends fourteen (14) days prior to Labor Day the next year) while being a member of a WSCA member club. The wins must have been from a class that followed WSCA rules and must have been won at an open show. Shows advertised as "fun days," "fun shows," etc. closed saddle club shows or show open to a limited number of horses or contestants are not eligible even though they have a WSCA judge. In team classes such as Rescue Race, Ribbon Race, etc. both members of the team as well as the horses must have qualified as a team. Regardless of what age group riders qualify in at the WSCA shows, they must ride in their proper age group at the Championship Show.

WSCA APPROVED SHOW

WSCA Inc. does **NOT** approve shows. WSCA approves judges and the rules in the WSCA Rulebook. How the show is run and what rules are followed is up to the show committee of the sponsoring organization. For classes in a show to qualify for the saddle club events at the Minnesota State Fair and the WSCA Championship Show, they must be judged by a WSCA approved judge, (that is, a judge on the WSCA approved judges list) and the class must follow WSCA rules.

Shows may have classes other than those listed in the WSCA Rulebook, or may modify or change the classes if they wish. Wins from these classes would **NOT** be qualifying wins, however, classes in the same show that did follow WSCA rules would qualify, in fairness to exhibitors, they must be notified before the class if it is not going to be a qualifying class and it should be stated on the show bill.

"Qualifying shows must be advertised on the "ON DECK" section of the WSCA website. All WSCA Saddle Clubs hosting qualifying shows must be published on the "ON DECK" section of the WSCA website seven (7) days before the date of the show, otherwise the show is non-qualifying. If a rain date is needed and the show is rescheduled within seven (7) days, the show does not need to be republished on the "ON DECK" WSCA website. If the show is rescheduled after the seven (7) days of the original show date,

the show must be republished on the WSCA website "ON DECK". If the show is hosted by a non-WSCA Saddle Club and has not been placed on the WSCA "ON DECK", the judge will determine if the show is an Open Show following WSCA rules.

In order for a show to be challenged, a signed letter of complaint must be sent to the Judges Committee prior to the deadline for the MN State Fair and/or WSCA Championship Show.

RECOMMENDATIONS FOR SHOW COMMITTEES

1. Individuals contacting judges in regard to serving as judge for their horse show should answer the judge's letter with either a letter of acceptance or non acceptance. Judges would like to keep their judging calendar in order and it is very difficult to do if they are not notified one (1) way or the other. Judges when contacted should answer the inquiry letter so show committees can contact other judges if he/she is unavailable.
2. It is recommended that show committees set their order of classes so that performance classes such as pleasure, reining, etc., are in the early part of the show before the timed events. Exhibitors desire it so. The judge should receive a copy of the show bill prior to the show.
3. All pony classes: Show programs should specify the size of pony and age of rider. Show committees should have someone in charge of measuring the ponies before their class.
4. Show bills should include:
 - a) Date, time, name of judge, place of show with complete directions or map on how to get to the show grounds.
 - b) A list of classes in order, complete with age group breakdowns, pay off percentages, etc.
 - c) If hunter, jumper classes are offered, height of jumps should be on the show bill.
5. Show committees must provide a safe environment for contestants and spectators including safety recommended equipment.
6. There should be provisions for running water or water for horses on the grounds. If no water is available, it should be noted in the show bill. There should be clean rest room facilities.
7. High point rules are at the discretion of the show committee. In fairness to exhibitors, they should be announced or put on the show bill. If a show has classes that are non-qualifying for the Championship show, it must be on the show bill and announced at the show.
8. It is up to the discretion of the show committee to regulate the number of horses ridden by the same rider in the events not presently covered in the WSCA Rulebook.
9. It is the responsibility of the contestant to see that he/she is entered in his/her proper classes with respect to age group, use of horse, etc.

10. Placing of Ribbons / Color			Points
1st	Blue		6
2nd	Red		5
3rd	Yellow		4
4th	White		3
5th	Pink		2
6th	Green		1

11. Placing of Ribbons for Championship Show only.

Placing of Ribbons / Color		Points
1st	Blue	10
2nd	Red	9
3rd	Yellow	8
4th	White	7
5th	Pink	6
6th	Green	5
7th	Purple	4
8th	Brown	3
9th	Gray	2
10th	Light Blue	1

WSCA APPROVED JUDGE

Designation as a WSCA Judge is a privilege, not a right, bestowed by the WSCA according to procedures formulated by it to individuals whose equine expertise and personal character merit the honor.

Any and all judges who are currently approved by the WSCA are expected to exhibit exemplary behavior, particularly at those shows following WSCA rules and being judged by an Approved WSCA Judge; but also at WSCA functions such as, but not limited to, banquets and meetings. This applies whether the individual is acting in capacity of Judge, exhibitor and/or spectator or merely passer-by. Complaints against a Judge in these instances shall be processed as any other complaint against a Judge.

The Judge is subject to continual committee review; and such designation, "Approved Judge", is revocable by the Judges' Committee with written notice and a formal hearing; subject only to ultimate review by the WSCA Board of Directors.

For further information or rules or procedures call or write the current chairman of the Judges' Committee as listed in a current edition of the "SPOTLIGHT".

GENERAL RULES

1. In order to ask for a rule addition, deletion or change, request forms and procedures from the Rulebook Committee. The Rulebook Committee will answer questions pertaining to the rulebook and keep a record of questions that arise between rulebook revisions and help clarify them in the next printing. Except for safety purposes, revisions will not take effect until the next printing of the rulebook.
2. Competitors at WSCA events during the Minnesota State Fair must comply with rules established by the Minnesota State Fair. A rider may ride for different clubs in different events if he/she is a member as of May 31 of that year.
3. All stallions, regardless of age, to be shown or ridden by a Senior only (eighteen (18) and over) and to be controlled. Youth (seventeen (17) and under) may show colts less than one (1) year of age. See also Additional Horse Terms.
4. Participants in all classes and events are to be attired in generally accepted western apparel, English apparel in English classes. Games are western events. Hats or helmets required in all events, games included, with the exception of classes where two (2) persons ride one (1) horse at one (1) time. **Note:** Refer to specific class rule.
5. In timed events, contestant must enter the ring wearing a hat or helmet. A penalty of one (1) second shall be assessed against an entry if the rider loses his/her hat or helmet and it falls to the ground. Penalty to be enforced from the time the contestant enters the ring till the time he/she leaves the ring. In the event that all horses are in the ring awaiting their turn to run, the rule will apply to the contestant making his/her run.
6. No re-rides permitted due to breakage/failure of equipment or a fall of horse and/or rider once the contestant has entered the course. In judged events (i.e. pleasure, horsemanship, reining, etc.) the event has begun when the judge begins judging and is complete when the judge has turned in the placing. In game classes, the course is defined as from the time the timer starts running and continues until the time stops. 1.) In Speed and Action, the course has ended after the time in the box is completed at the end of the run. 2.) In Egg and Spoon the course begins when the judging begins and ends when a winner is declared.
7. Two (2) handed ride permitted in timed events. No whips, quirts or facsimile in western or game classes. Only wide flat leather bats (picture on page 20) are allowed on contestant, horse, and saddle or in the class. Bat to be used behind the cinch only. Bats are to be held so the wide part is used on the horse. Spurs permissible if used behind the cinch, not to be used in excess. Contestant may hit the horse with hand behind the cinch. To be enforced from the time the contestant enters the ring till he/she leaves the ring. In the event that all horses are in the ring awaiting their turn to run, the rule will apply to the contestant making his/her run.
8. Excessive use of whips, bats, spurs or abuse of horse or pony will be cause for dismissal or disqualification from class.

9. Electric timer preferred in all timed events, however, backup stop watch must be used after three (3) malfunctions of the electric timer, and should be read by two (2) people. If timer fails, contestant has the option to receive a rerun or back up stop watch time if available. The choice to be made by the rider before the time is announced. If timer is not available, two (2) stop watches to be used. (One (1) watch to be used as a back-up). If stop watches are used, watch should not be operated by the judge.
10. In the event of ties in a timed event, the tie is to be run off between the riders involved. Best time of the run to place in order. In event of tie the horse declared the winner in the run off must re-run the pattern within two (2) seconds of its original time or the run off must be held again. OR, IF BOTH RIDERS AGREE, A FLIP OF A COIN CAN BE USED TO DETERMINE THE WINNERS, INSTEAD OF A RUN OFF.

11. Western Pony Under Saddle – Suggested Size Limits

13.2 Hands and under (54") (Current Championship Show size limit)

12 Hands and under (48") (Current State Fair and Championship Show Pet Pony size limit)

12. No tie downs, running martingales (exceptions: see Hunter/Jumper rule), draw reins or facsimile in any judged event. No closed reins in western pleasure and western horsemanship with the exception of romal and bosal reins. If romal reins are used, hobbles are not required.
13. In timed events the rider is not allowed to go past the area of the time line before beginning his/her run.
14. Intentionally dropping of the reins during a timed event constitutes disqualifications. To be enforced from the time the contestant enters the ring until he/she leaves the ring.
15. Any breaking of the pattern means disqualification, circling of the props more than once, backing, changing of direction or similar are NOT considered breaking of pattern and the timer will take care of it.
16. Dress Code: Western attire in all western events. Contestant must wear western boots, western hat (see also helmet rule), dress or western long or short sleeved shirt with collar, western pants or jeans. Vest, coat, sweater, belt, chaps or equitation suit optional. Lariat and/or slicker optional. Dress code may vary in certain classes; see specific, class rules. Dress code may be relaxed only in the event of severe weather. (That decision to be made by the judge and/or show committee.)

Attire NOT allowed: sleeveless shirts; capped sleeve shirts; T-shirts (defined as an undershirt type of garment with no collar). Only Western equipment in Western events. Only Hunt Seat equipment in Hunt Seat events. Only Saddle Seat equipment in Saddle Seat events.

Safety Helmets: A rider may at his/her discretion wear

appropriate protective headgear with secured harness in any event. (An illustration of the helmet is available on page 79.)

See specific class rules for allowable variations.

17. An unruly horse may be dismissed from the class by the judge at any time.
18. Curb may be a flat strap, flat chain or double flat chain, but no twist allowed. (Picture page 20.) This holds in all judged events. A two (2)-handed ride using a bosal or smooth snaffle bit with broken mouth-piece (conventional D-ring, O-ring or egg butt) is permissible in all judged events providing the horse is five (5) years old or younger. The snaffle ring should not be larger than four inches (4") and one inch (1") from the cheek must be a minimum of three-eighth inch (3/8") in diameter with a gradual decrease to center of snaffle. A loose chin strap with the reins attached above the chin strap is optional. No mechanical hackamores or facsimile to be used in any judged events.
19. Age of the rider is to be computed as of the 1st of January of the current year. Rider is to ride in his/her own age group if age groups are offered. If the show states merely Junior/Senior, Junior is to be seventeen (17) and under and Senior is to be eighteen (18) and over. Age breakdowns, if offered, MUST be chosen from the following:

Choices for under seventeen (17) are:

- a) **Seventeen (17) and under "Junior"**
- b) **Thirteen (13) and under "Junior",
Fourteen – Seventeen (14-17) "Intermediate"**
- c) **Ten (10) and under "Pee Wee",
Eleven – Thirteen (11-13) "Junior",
Fourteen – Seventeen (14-17) "Intermediate"**

Choices for over eighteen (18) are:

- a) **Eighteen (18) and over "Senior"**
- b) **Eighteen – Thirty-four (18-34) "Senior",
Thirty-five (35) and over "Senior Plus"**
- c) **"Senior eighteen – twenty-nine (18-29)",
"Senior Thirty – thirty-nine (30-39)",
"Senior Forty – forty-nine (40-49)",
"Senior Fifty (50) and over"**
- d) **Eighteen – thirty-four (18-34),
Thirty-five – forty-nine (35-49),
Fifty (50) and over**
- e) **Eighteen – thirty-four (18-34),
Thirty-five – forty-nine (35-49),
Fifty – sixty-four (50-64),
Sixty-five (65) and over**

20. A horse or a pony may be used only once in any event per show. (Senior, Junior, Intermediate, Men's, Women's, etc. are considered to be class divisions and not separate events.) A horse may be used in only one (1) saddle seat equitation, one (1) showmanship at halter; however, this does not apply to a horse being used in bareback horsemanship, tandem bareback and lead line. A rider may ride in only one (1) western horsemanship class per show with the following exceptions: pony horsemanship, tandem bareback, bareback horsemanship.

21. In Rescue Race, Pick up Race, Relay Race, Ribbon Race, Bareback

Pickup Race, Monkey in the Tree, Cowhide Race, Scoop Shovel Race, the contestant may enter the ring twice. (May ride twice, may be picked up twice, or ride once and be picked up once.) Horse to be used only once per event.

22. Gate must be closed in all events when the event is in progress unless in the opinion of the judge or show committee the closed gate would be too hazardous, in games, gate must be closed while the contestant makes his/her run. No running through the gate at start or finish.

23. In judged classes, a contestant is allowed a maximum of two (2) minutes to get to the ring after the class is called and/or his/her number is called. If more time is going to be needed for tack change, etc. ringmaster must be notified ahead of time.

24. During any events involving children, rider can be accompanied by an adult with or without a lead line, **MUST FOLLOW SAME RULES FOR CLASS**, i.e.; horse/rider and handler must cross timeline together. Horse/rider and handler must follow proper attire rules. A first or second placing from this type of run will not qualify rider for Championship Show.

25. Classes are to be split if they are too large for the ring to adequately handle.

26. Each contestant must wear his/her correct number. A pleasure rider has the following options: a number worn on his/her back or two (2) numbers, one (1) pinned on each side of the saddle blanket. A game rider has the following options: a number worn on his/her back or a number pinned on either side of the saddle blanket. In driving classes the driver may wear the number on his/her back or on the back of the cart.

27. Only horses or ponies allowed in WSCA classes. Mules or donkeys or other equine crosses are not allowed.

28. Judges decisions are final.

NOTE:

Any act of discourtesy or disobedience to the officials on the part of the owner, contestant or contestants, will disqualify the horse and rider for the remainder of the show and the owner shall forfeit his/her entry and other fees. Owner and/or rider may be liable for disqualification in saddle club events at the Minnesota State Fair and all events at the WSCA Championship Show, if deemed necessary by the WSCA Board of Directors at a review meeting. The management reserves to itself the power to remove any owner, contestant, contestants or horses from the show without being liable for compensation. WSCA has adopted the following provision for the mutual benefit of members and with the intention of reducing the WSCA's litigation expenses, which expenses would ultimately be borne by members and non-members participating in WSCA activities. Every member by joining a WSCA Club, or non-member, participating in WSCA events, does thereby agree if unsuccessful in an attempt to overturn WSCA's decisions, action, rules or regulations, to reimburse WSCA for its reasonable attorney's fees, court costs and other expenses in defense of such suit.

APPROVED SAFETY EQUIPMENT

Mandatory for all WSCA shows

I. Barrels: **(both ends closed)**

- a) Rubber or plastic barrel, white or painted white, approximately fifty-five (55) gallon size.

II. Poles

- a) Rubber base.
- b) Plastic pipe, painted white, height eighty inches (80") minimum, ninety-six inches (96") maximum.

III. Jumping props:

- a) Standard
 - 1) Rubber sixteen inch (16") highway cones, painted white, notched on top to receive crossbar or
 - 2) Rubber pole brackets for crossbar.
 - 3) Blok training system white plastic jump block.
- b) Crossbar
 - 1) Plastic pipe, ten feet (10') minimum, twelve feet (12') maximum, white or painted white.
- c) Timing Poles
 - 1) No more than five feet (5') from rail etc. unless timer requires a narrow corridor.

Classes held without Safety equipment will not qualify for State Fair or Championship Show.

Information on where to obtain the equipment may be obtained from the chairman of the Safety Committee or the WSCA Executive Secretary.

ADDITIONAL SUGGESTED EQUIPMENT

Game Equipment:

PA system, WSCA Rulebook, Electric Timer, Stop Watches, Fifty foot (50') Tape Measure, Duct Tape

- a. Three – Seven (3-7) Approved Barrels (seven (7) for FOUR IN LINE)
- b. Eight (8) Approved Poles (two (2) for time line)
- c. Two – Four (2-4) Approved Standards, Cones or Pole Brackets
- d. One – Three (1-3) Approved Crossbars (includes extras)
- e. # Spoons (uniform in size, teaspoons)
- f. # Eggs (uniform size)
- g. One – Two (1-2) Pails (not to exceed five (5) gallons)
- h. # Multi Color Pennants (pennants to be approximately half inch (1/2") in diameter and twelve inches (12") to eighteen inches (18") in length. Flag to be approximately six inches by eight inches (6" x 8").

Also:

Balloon Contest: # Balloons

Bat Race: Baseball bat

Cowhide or Scoop Shovel Race: Cowhide or scoop shovel, thirty foot (30') rope

Four in Line: Seven (7) Barrels and stop watch

Goat Typing: Goat and four foot (4') peggin' string

Keyhole Race or Key Race: Twine, chalk, lime, six (6) poles
 Musical Tires or Sacks or modified Musical Tires or Sacks: # Tires or sacks and radio
 Monkey in the tree: Tire, rope, etc.
 Package Race: Package and wearing apparel
 Pop Race: # Bottles of pop
 Potato Race: # Potatoes and container
 Relay Race Team: Four (4) poles or barrels, baton, pylons or pole markers
 Ribbon Race: # Crepe paper ribbon, eighteen inches (18") long and approximately two inches (2") wide
 Ride a Buck: # Dollars bills or paper cut to size
 Ring Race: Spear approximately thirty inches (30"), # rings, etc.
 Scudda-Ho: Four (4) poles, two (2) crossbars and brush, four (4) approved standards, three (3) barrels
 Water Race: Water, buckets or pans, pop or soda bottles, # paper cups

Pleasure Equipment:

- a) Cones, for patterns
- b) Tape measure, for patterns, jumps, etc.
- c) Measuring tape or stick, for pony height
- d) Magnet, for bosal content
- e) Stop watch, for timed trail pattern, jumping etc.
- f) Jump standards, rails, etc. for jumping division
- g) Log, gate, cones, for western riding
- h) Trail equipment One – Three (1-3) mandatory

1. Gate	2. Four (4) Logs
3. Bridge	4. Cones
5. Mailbox	6. Slicker
7. Jump Equipment	8. Object to drag

ACCEPTABLE CURB CHAINS

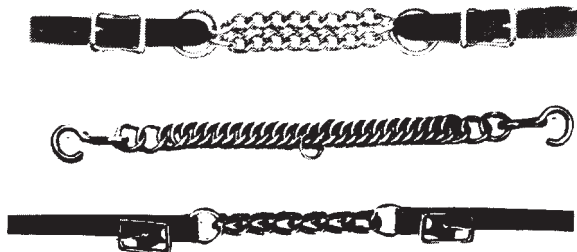

WHIPS, QUIRTS OR CROPS NOT ALLOWED IN WESTERN JUDGED CLASSES AND GAMES

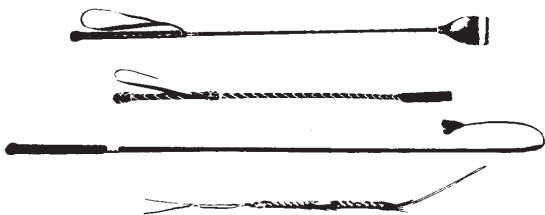

LEATHER BATS ALLOWED IN GAMES ONLY



EXPLANATION OF CLASSES PLEASURE:

Costume Class, Open – Hats not required

To be judged fifty percent (50%) on **originality**, twenty-five percent (25%) on costume and twenty-five percent (25%) on performance.

Routine at the discretion of the judge.

Suggestion: For safety sake, rail work should consist of walk, trot or pleasure gate only.

Equitation: English Open

Rider may ride in only one (1) English Equitation class per show. Rider should have an efficient comfortable appearance, hands light and supple and convey the impression of complete control of his/her mount. Whether riding hunt or saddle seat, the rider should show his/her horse to its best advantage. The position of the rider should be complementary to the type of horse he/she is riding, hunt or saddle seat. Attire and tack should be suitable for the type of riding style. No mixing of hunt and saddle seat equipment and attire. Spurs of the unrowelled type, whips or crops optional, however, excessive use of the whip will be cause for dismissal from the class. Class is to enter the ring and proceed around the ring at each gait, and on command, reverse and repeat. The order to reverse may be executed by turning either towards or away from the rail. Entries shall line up on command. Any or all riders may be asked by the judge for additional workout.

Equitation: English Hunt Seat

Rider may ride in only one (1) English Hunt Seat Equitation class per show. That same person may ride in a Saddle Seat Equitation class at the same show only if a different horse is used. Rider should have a workmanlike appearance; seat and hands light and supple, conveying the impression of complete control should any emergency arise. Spurs of the unrowelled type, whips or crops optional; however, excessive use of the whip will be cause for dismissal from the class. Suitable hunt seat attire. No mixing of hunt and saddle seat equipment or attire. Class is to enter the ring and proceed around the ring at each gait, and on command, reverse and repeat. The order to reverse may be executed by turning either towards or away from the rail. Light contact with horse's mouth is recommended. Entries shall line up on command. A pattern may be substituted by or supplemented with rail work, so long as all three (3) gaits including both leads, and a back are included in the pattern. Applies to all horsemanship and equitation classes except pony.

Suggestion: Individual workouts or patterns are highly recommended.

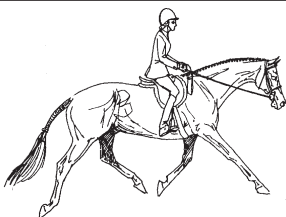

Equitation: English Saddle Seat

Rider may ride in only one (1) English Saddle Seat Equitation class per show. That same person may ride in a Hunt Seat Equitation class at the same show only if a different horse is used. In saddle seat equitation classes, riders should convey the impression of effective and easy control. The equitation seat should not be exaggerated but be thoroughly efficient and most comfortable for riding the type of horse called for at any gait and for any length of time. To show a horse well, he/she should show himself /her to the best advantage. Ring generalship shall be taken into consideration by the judge; however, poor ring manners will be penalized. Suitable saddle seat attire and tack. No mixing of hunt and saddle seat equipment or attire. Spurs of the unrowelled type, whips, or crops optional; however, excessive use of the whip will be cause for dismissal from the class. Class is to enter the ring and proceed around the ring at each gait, and on command, reverse and repeat. The order to reverse may be executed by turning either towards or away from the rail. Entries shall line up on command. Any or all riders may be asked by the judge for additional workout.

Suggestion: Individual workouts or patterns are highly recommended.

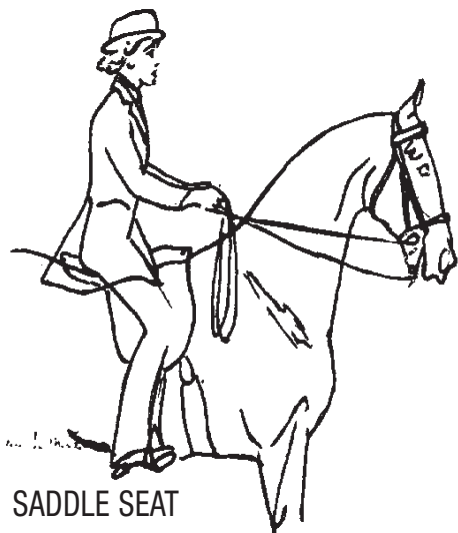

Horsemanship: Western

Riders will be judged on seat, hands, legs, ability to control and show horse. Results as shown by performance of horse are NOT to be considered more important than the method used by the rider in obtaining them.

Class Routine:

All horses are to be judged at a jog or pleasure gait, walk and lope. They shall be worked both ways of the ring and shall always be on the correct lead. The reverse is to be executed away from the rail. They are required to back. At the option of the Judge a pattern may be used at any time while the class is in progress.

Basic Position:

Rider should sit in the saddle with legs hanging straight to slightly forward in the stirrups. The stirrups should be just short enough to allow the heels to be lower than the toes. Body should always appear comfortable, relaxed and flexible.

Position in motion:

Rider should sit to the jog or pleasure gait and should not post. At the lope, he/she should be close to the saddle. All movements of the horse should be governed by the use of imperceptible aids. Exaggerated shifting of the rider's weight is not desirable.

Hands:

Both hands and arms shall be held in a relaxed easy manner with the upper arms to be in a straight line with the body. The arm used in reining shall be bent at the elbow. Free hand shall be partially closed and relaxed. Reins are to be carried immediately above or slightly in front of the saddle horn. Only one (1) hand is to be used for reining (unless bosal or snaffle is appropriately used). Rein hand may not be changed.

Mounting:

- a. The horse is to be controlled by a take up of the reins in the left hand. Reins are to be adjusted evenly with enough tension so that the rider can feel the bit. The horse is to be held steady. Ends of the reins hang on the near side while the rider is mounting.
- b. The rider shall check the cinch to be sure that the saddle is secure. The rider shall then place the left foot into the stirrup. Grasping the horn or pommel with the right hand, the rider springs off the right foot, staying close to the horse. The rider shall settle in the saddle.
- c. The rider shall slip the right foot into the off stirrup and assume the basic riding position.
- d. The ends of split reins shall hang on the side of the reining hand.

Dismounting:

Reversing the above position, the rider steps down and face the horse's head.

Appointments:

Clothing shall be clean, workmanlike, and neat. (See dress code elsewhere in rulebook.) Chaps are optional; however, the judge may ask that chaps not be used. Spurs, lariat and slicker are optional. The saddle shall fit the rider and horse.

see diagram on following page

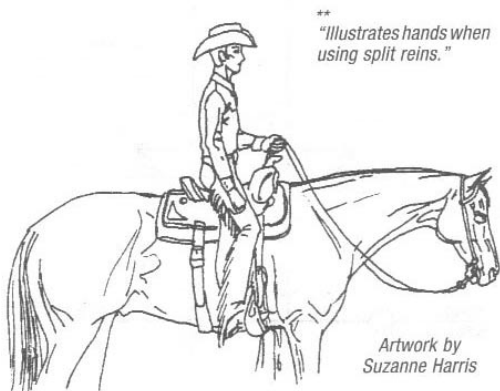
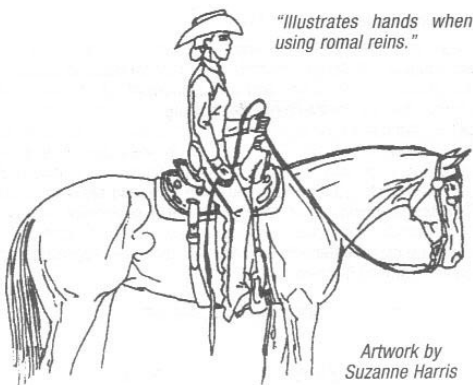

Bareback Western Horsemanship

To be judged as a western horsemanship class. Equipment not allowed: bareback pads with or without stirrups.

Lead Line Equitation or Horsemanship – Six (6) and under

May be Western or English but rider, leader and equipment must be consistent. The Lead Line class will apply to six (6) and under age groups only and if a rider rides in a Lead Line Equitation class he/she will be ineligible to ride in any other equitation class for older age groups. The rider will be judged on his/her basic position in the saddle, hand position, leg position, seat position, back position and ability to properly hold the reins and aid and cue the mount. A lead shank must be attached to the bridle bit or to a halter that is under the bridle so that while the rider is on the rail the horse could be controlled by the person leading the mount if necessary. As the judge asks the rider to back the horse in the line up, the leader should not

aid the rider. The leader should only keep the horse under control. No contestant in the Lead Line class will be allowed to be tied, buckled or fastened in the saddle in any manner. To be judged at a walk both ways of the ring and to stop and back.

Open Halter – Western or English

Entries are to be judged individually, standing, at a walk and a trot or pleasure gait. Only one (1) handler per horse. No whips, crops, etc. allowed. With horses that are normally shown in a stretched position, the judge at his/her discretion, may ask the handler to have the horse stand square on all four (4) feet, not stretched, in order to better observe conformation. To be judged on conformation, quality, substance and soundness. Breed type shall receive consideration, but not over the above listed qualities. Unruly or ill mannered horses will be excused from the ring. In a specific breed halter class at a WSCA show where a whip is normally used to show the horse (ex. Morgan halter, Arabian halter, etc.) a whip is permissible.

Pair Class – Open

To be shown at a walk, trot or pleasure gait and lope. To be judged as a matched pair.

Fifty (50) percent performance

Twenty-five (25) percent similarity of tack and appointments rather than cost of same

Twenty-five (25) percent similarity of conformation of horses and ability of riders to ride as one

May be shown by a man and woman, two (2) women, two (2) men, etc. Must be shown in stock saddle.

Pair Class Divisions

Pair Class

Same requirements as Open Pair Class except the pair must be man and woman.

Color Pair Class

Judged the same as Open Pair Class except for the following percentages:

Twenty-five (25) percent performance

Twenty-five (25) percent color

Twenty-five (25) percent similarity of tack and appointments rather than cost of same

Twenty-five (25) percent similarity of conformation of horses and ability of riders to ride as one

Open Driving

Horses are to be shown in show harness, bridle with or without blinkers and over check or side check, snaffle bit (straight or jointed) or traditional driving bit. Equipment to be in sound condition, two (2) or four (4) wheeled vehicle suitable to the horse or pony. Horses to enter the ring at a normal trot or pleasure gait. To be shown at a walk, normal trot or pleasure gait and strong trot or road trot. Extreme speed to be penalized. Horses are to work both ways of the ring making the reverse under the direction of the ringmaster. Horses are to stand quietly and back readily. Judged on manners, way of going

as appropriate to breed and or conformation and apparent ability to give a good pleasure drive. Attire of driver (whip) should be suited to vehicle, driving style and or horse or pony breed, etc. with head attire optional.

Open Reinmanship

A driving class in which entries are judged primarily on the ability and skill of the driver. Drivers may be asked to complete an individual workout with pattern to be determined by the judge. To be judged: Seventy-five (75) percent on handling of reins and whip, control, posture and overall appearance of driver and horse, twenty-five (25) percent on the condition of harness and vehicle and neatness of attire.

Pleasure: Open English

Horse may be shown in only one English Pleasure class per show. Horses are to be judged on performance, apparent ability to give a good pleasure ride; manners and gaits are to be considered highly in judging. Contestant will be penalized for excessive speed or being on the wrong lead. Horses are to be shown at a flat footed walk, square trot (with rider posting) or pleasure gait, and canter on a reasonably light rein but still maintaining contact with the horse's mouth. Horses are to be worked both ways of the ring at all three (3) gaits. They shall not be asked to extend the canter. An extended trot or pleasure gait should be required at least one (1) way of the ring. Horses are to be brought to a flat footed walk before changing gaits if a saddle seat exhibitor is present in the class. Horses are to be reversed to the inside (away from the rail) or outside (into rail). They may be required to reverse at walk, or trot at the discretion of the judge, but shall not be asked to reverse at the canter. Judge must ask horses to back. Horses are to stand quietly and back readily. Riders shall not be required to dismount for any reason. Contestants shall show in tack attire appropriate to either Saddle Seat or Hunt Seat. No mixing of hunt and saddle seat equipment. Martingales, tie downs, hackamores, draw reins, etc. prohibited. Unrowelled spurs, whips, crops optional; however, excessive use of whip will be cause for dismissal from class.

Pleasure: English Hunt Seat

Horse may not cross enter in English Pleasure Saddle Seat. Horses are to be shown at a walk, trot or pleasure gait and canter both ways of the ring. Horses are required to back but the judge may require, at his/her discretion, the backing of only the finalists in the class. Emphasis shall be placed on actual suitability to purpose. It is the judge's option to require an exhibitor to extend any gait. Horses are to be reversed to the inside (away from the rail) or to the outside (toward the rail). They may be required to reverse at the walk or trot or pleasure gait at the discretion of the judge, but shall not be asked to reverse at the canter. Horses are to back easily and stand quietly. Light contact with horse's mouth is recommended. At the option of the judge, the top eight (8) horses may be required to gallop collectively one way of the ring, but never more than eight (8) at one (1) time.

Suitable hunt seat attire shall be worn. No mixing of hunt and saddle seat equipment or attire. Martingales, tie downs, draw reins, hackamores, etc. prohibited. Unrowelled spurs, crops or bats optional; however, excessive use of whip shall be cause for dismissal from class.

Pleasure: English Saddle Seat

Horses may not cross enter in English Pleasure Hunt Seat. Horses are to be judged on performance and ability to give a good pleasure ride with emphasis on style, manners, and gait. Horses are to be shown at a flat footed walk, square trot (with rider posting) or pleasure gait, and canter on a reasonably light rein but still maintaining contact with the horse's mouth. Horses are to be worked both ways of the ring at all gaits. They shall not be asked to extend the canter. An extended trot is optional. Horses are to be brought to a flat footed walk before changing gaits. Horses may reverse inside (away from the rail) or outside (into the rail). They may be required to reverse at the walk, trot or pleasure gait at the discretion of the judge, but shall not be asked to reverse at the canter. Horses are to stand quietly and back readily.

Horses and riders are to be shown in English tack and attire appropriate for a Saddle Seat English Pleasure class for their particular breed (ex. Tennessee Walking Horses use a walking horse bit and the riders do not wear derbies). No mixing of hunt and saddle seat equipment. No martingales, tie downs, hackamores, draw reins, etc. Unrowelled type spurs, crops, whips optional; however, excessive use of whip shall be cause for dismissal from class. Boots of any description for use on the horse are prohibited.

Snaffle Bit Western Pleasure Class

Class to be limited to two (2), three (3) or four (4) year old horses, or any combination of two (2), three (3) or four (4) year old horses. Must be shown as a western pleasure horse in a bosal or snaffle bit and rider must use two (2) hands.

A snaffle bit is defined as a smooth mouthed bit with a broken mouthpiece (conventional o-ring, egg-butt, or d-ring) and the ring no larger than four inches (4"). One inch (1") in from the cheek must be a minimum three-eighth inch (3/8") in diameter with a gradual decrease to the center of the snaffle. If an optional loose leather or nylon curb strap is used, the reins are to be attached above it.

Bosal must be round in shape and constructed of braided rawhide or leather and must have a soft, flexible non-metallic core. No other material of any kind may be used in conjunction with the bosal such as steel or metal attachments or chains.

Pleasure: Western

Horse and/or pony may be shown in only one (1) Western Pleasure class per show.

- a) Horses and/or ponies are to be shown at a walk, jog or pleasure gait and lope.
- b) To be judged on manners and performance and ability to give good pleasure ride.
- c) To be shown with a reasonable loose rein.
- d) Judge may ask finalists for additional workouts.
- e) Judge may ask for the reverse at the walk and the trot or pleasure gait. The reverse shall not be called for at the lope.
- f) It is the judge's option to extend any gait.
- g) Horses are to be asked to back.

Pleasure: Western Bridle Path

Horses showing in another western pleasure class may not show in this class. The western pleasure bridle path horse is collected, moves with natural animation and an obvious degree of carriage.

- a) Horse is to be shown at a walk, trot or pleasure gait and lope.
- b) Horse to be asked to back.
- c) Judge may ask for an extended walk and trot or pleasure gait.
- d) Western attire and equipment.
- e) Full and natural mane and tail required.
- f) Whips, bats, crops, leg wraps, shin boots, or similar not allowed.
- g) An artificially built-up hoof is not allowed.

Pleasure: Western Non Stock Type

Open to horses that are lighter in build than the stock horse breeds including, but not limited to, horses of Arabian, Morgan and/or Saddlebred type.

- a) To be shown as a walk, jog or pleasure gait, and lope both directions of the ring. Extended gaits optional. Backing is required.
- b) To be judged on manners, performance, ability to give a good pleasure ride, attitude, and quality.
- c) Horses may be shown on light contact with the poll higher than the withers and may be higher in the bridle and in a more collected frame than would be typical of a stock horse type, but should still demonstrate the ease and calmness of western pleasure.
- d) Cross entry is not permitted to open Western Bridle path or any other western pleasure class.
- e) Animation not to be penalized.

Western Pony Pleasure

(See Pleasure: Western.....page 27)

Western Pony Under Saddle – Suggested size limits

13.2 hands and under (54")

(Current Championship Show size limit)

12 hands and under (48")

(Current State Fair and Championship Show Pet Pony size limit)

Pony Roadster Class

Pony enters ring counter clockwise at a jog trot or pleasure gait. The speed is increased to a road gait (which is a faster trot or pleasure gait). The pony is brought down to a jog trot or pleasure gait, and reverses at a jog trot or pleasure gait. After the reverse he/she travels at a jog trot or pleasure gait and then is stepped up to a road gait again and is turned on to a race gait. After completing the race gait he/she is brought down to a jog trot or pleasure gait, and then is lined up for judging. The pony is hitched to a two (2) wheel cart or sulky with stirrups, not baskets. The driver must wear colors. There can be no attendant.

Driver is not allowed to get off the cart to park his/her horse. The only time a driver may get off his/her cart is in case of equipment break down and then he/she pulls to the center of the ring and the judge asks the other contestants to drive at ease while repair is being made. The judge has the right to dismiss any pony and driver at any time, who is unruly or disturbing others in the ring. The pony must keep his/her form in the jog trot or pleasure gait and race gait and must come in and park in an orderly manner. A roadster pony never walks.

Reining Horse Class (Performance class)

Skid boots, shin boots optional. Nosebands prohibited.

General rules of reining – in a show, any one of the five (5) reining patterns may be used. One (1) of these five (5) patterns is to be selected by the judge of the class at the show and used by all contestants in the class.

Each contestant will perform the required pattern individually and separately. Horse shall rein and handle easily, fluently, effortlessly, and with reasonable speed throughout the pattern. Any horse not following exact pattern will be disqualified. Continuous rein prohibited.

Scoring will be on the basis of sixty (60) to eighty (80), with seventy (70) denoting an average performance. Each horse will be judged on the neatness, dispatch, ease, calmness and speed with which it performs the pattern.

A judge may require any contestant to repeat the performance of any or all of the various parts of the pattern.

Faults against the horse (to be scored accordingly but not to cause disqualification):

- a) Opening mouth excessively (when wearing bit).
- b) Excessive jawing, open mouth, or head rising on stop.
- c) Breaking gaits.
- d) Lack of smooth, straight, stop on haunches (bouncing or sideways stop).
- e) Refusing to change leads.
- f) Anticipating signals.
- g) Stumbling.
- h) Wringing tail.
- i) Backing sideways.
- j) Knocking over markers.

Faults against the rider (to be scored accordingly, but not to cause disqualification).

- a) Changing hands on reins.
- b) Two (2) hands on reins (except horses using a bosal).
- c) Losing stirrup or holding on.
- d) Any unnecessary aid given by the rider (such as unnecessary talking, petting, spurring, quirting, jerking of reins, etc.).
- e) In reining patterns one (1), two (2), three (3) and five (5), failure to run circles or figure eights (8) within the markers is not considered a fault.

Contestant should not start the reining pattern until given signal from the judge.

REINING PATTERN NUMBER 1

The arena or plot should be approximately fifty feet by one-hundred-fifty feet (50' x 150') in size. The judge shall indicate with markers on arena fence or wall the length of the pattern. Markers within the area of the pattern will not be used.

Ride pattern as follows:

- 1) Run to the far end of the arena, stop and do two (2) – half (1/2) spins to the left – no hesitation.
- 2) Run to the opposite end of the arena, stop and do two (2) – half (1/2) spins to the right – no hesitation.
- 3) Run past center of center, do sliding stop, no hesitation, back over side tracks to center, hesitate.
- 4) Make a quarter (1/4) pivot to the left to face left wall – hesitate.
- 5) Begin on right lead and make two (2) circles to the right, the first small and slow the second large and fast. Change leads at center of arena.
- 6) Make two (2) circles to the left, first small and slow the second large and fast. Change leads at the center of arena.
- 7) Begin a large fast circle to the right. Do not close this circle but run straight down the side past the center, do a sliding stop. (Stop to be at least twenty feet (20') from wall or fence.)
- 8) Walk to judge and stop for inspection until dismissed.

REINING PATTERN NUMBER 1

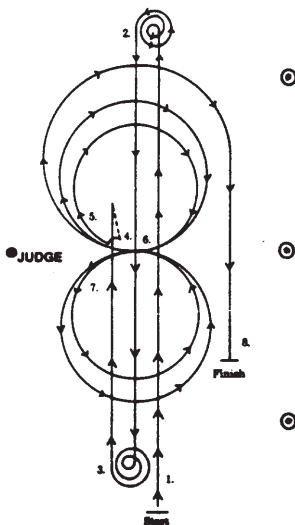

REINING PATTERN NUMBER 2

The arena or plot should be approximately fifty feet by one hundred-fifty feet (50' x 150') in size. The judge shall indicate with markers on arena fence or wall the length of the pattern. Markers within the area of the pattern will not be used.

Ride pattern as follows:

- 1) Run with speed, past center marker.

- 2) Stop and back up to center of pattern.
- 3) Settle horse for approximately ten (10) seconds.
Quarter (1/4) turn left, start lope. Circles should be made inside the end markers.
- 4) Ride two (2) circles to the right, first circle small, should be slow and second circle larger and faster.
- 5) Ride two circles to the left, first circle small and slow, second circle larger and faster.
- 6) Left roll back over hocks (should be made past far end marker).
- 7) Right roll back over hocks (should be made past near end marker).
- 8) Stop (should be made past center marker). Let horse settle, then in approximate area of stop, do the spins.
- 9) Do one (1) three hundred-sixty (360) degree spin either right or left.
- 10) Do one (1) three hundred-sixty (360) degree spin in the direction opposite that done in step 9.
- 11) Walk to judge and stop for inspection until dismissed.

**REINING PATTERN
NUMBER 2**

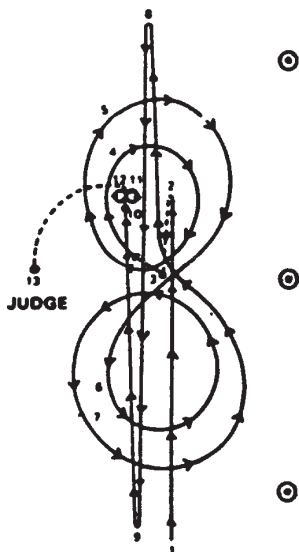

MANDATORY MARKER ALONG FENCE OR WALL

REINING PATTERN NUMBER 3

The arena or plot should be approximately fifty feet by one hundred-fifty feet (50' x 150') in size. The judge shall indicate with markers on arena fence or wall the length of the pattern. Markers within the area of the pattern will not be used.

Ride pattern as follows:

- 1) Walk to center of the arena, stop horse should be facing left wall or fence.
- 2) Complete two (2) spins to the left.
- 3) Complete two (2) spins to the right. Hesitate.

- 4) Begin on right lead and complete two (2) circles to the right. The first circle large and fast – the second circle small and slow.
- 5) Change leads at center of the arena.
- 6) Complete two (2) circles to the left. The first circle large and fast – the second circle small and slow.
- 7) Change leads at center of the arena.
- 8) Begin a large fast circle to the right. Do not close this circle but run straight down the side past center marker and do a left roll back at least twenty feet (20') from wall or fence, no hesitation.
- 9) Continue back around top half of previous circle, do not close this circle but run straight down opposite side of the arena past center marker and do a right roll back at least twenty feet (20') from wall or fence – no hesitation.*
- 10) Continue back around previous circle, do not close this circle but run straight down the side past the center marker and do a sliding stop at approximately twenty feet (20') from wall or fence.
- 11) Back straight to center of the arena.

*Horse may come out of roll back on either lead; however, it should be on correct lead when going around the end of the arena.

REINING PATTERN
NUMBER 3

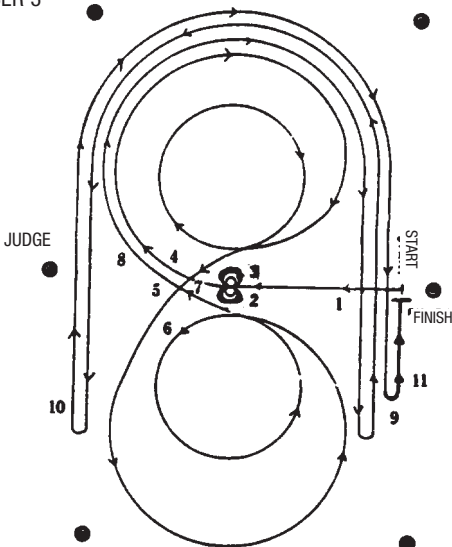

MANDATORY MARKER ALONG FENCE OR WALL

REINING PATTERN NUMBER 4

The arena or plot should be approximately fifty feet by one hundred-fifty feet (50' x 150') in size.

- 1) Begin work to the right.
- 2) First figure eight, slow
- 3) Second figure eight faster. Second figure eight is not completed until a lead change takes place at point A. At rider's option either walk or trot from B to C. Then complete rest of pattern.
- 4) Begin run.
- 5) Sliding stop.
- 6) Turn away from the rail, do a spin and a half (1/2), no hesitation.
- 7) Sliding stop.
- 8) Turn away from the rail, do a spin and a half (1/2), no hesitation.
- 9) Sliding stop.
- 10) Back over slide marks. Face judge, walk a few steps.
- 11) Pivot right or left, no more than ninety (90) degrees.
- 12) Pivot the opposite direction, no more than one hundred-eighty (180) degrees.
- 13) Pivot in direction taken in eleven (11), no more than one hundred-eighty (180) degrees.

REINING PATTERN NUMBER 4

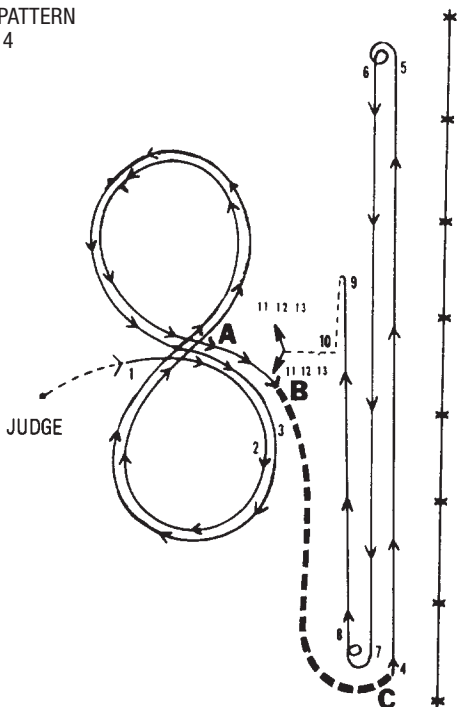

MANDATORY MARKER ALONG FENCE OR WALL

REINING PATTERN NUMBER 5

The arena or plot should be approximately fifty feet by one-hundred fifty feet (50' x 150') in size. The judge shall indicate with markers on arena fence or wall the length of pattern. Markers within the area of the pattern will not be used.

- 1) Starting in the center of the arena, make a large fast circle to the right.
- 2) Draw the circle down to a small circle until you reach the center of the arena – stop.
- 3) Do a double spin to the inside of the small circle in the center of the arena – at end of spins horse should be facing the left wall – slight hesitation.
- 4) Begin on left lead and make a large fast circle.
- 5) Then a small circle again drawing it down to the center of the arena – stop – no hesitation on these stops.
- 6) Do a double spin to the inside of the circle – slight hesitation – horse to be facing left wall.
- 7) Begin on right lead and make a fast figure eight over the large circles – close the eight – and change leads.
- 8) Run to far end and do a left roll back.
- 9) Run to opposite end of the arena and does a right roll back.
- 10) Run back past center of the arena and do a sliding stop – hesitate.
- 11) Back over slide tracks.
- 12) Finish – walk to judge for inspection and dismissal.

REINING PATTERN
NUMBER 5 · · · ·

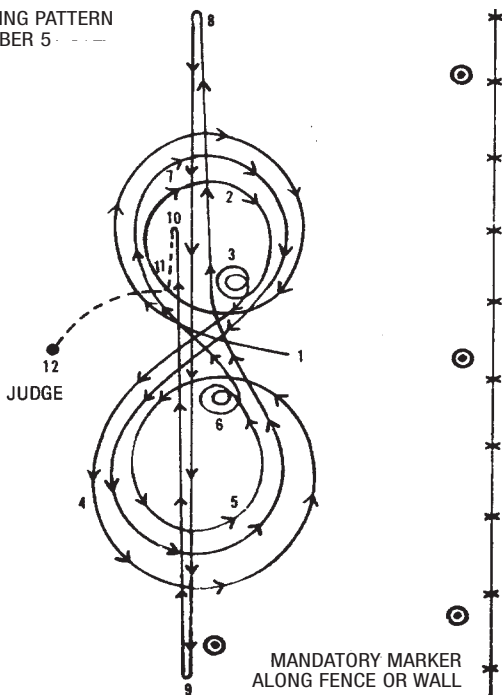

Showmanship at Halter

Contestant to show as in halter division. The horse is merely a prop. Handler to receive fifty (50) percent, grooming of horse is to receive forty (40) percent and neatness of handler is to receive ten (10) percent. No preference shall be given to breed, color or size.

Contestant may show in either English or Western attire. If exhibitor wears English attire, horse must be shown in appropriate halter or English bridle. If exhibitor wears Western attire, a horse must be shown in appropriate halter. Whips, crops or quirts are not allowed.

1. Ability to show horse at all times.
2. Neatness in grooming and trimming.
3. Condition of horse.
4. Neatness of exhibitor.
5. Ability to make horse stand squarely on all four (4) feet.
6. Neatness of lead line carried in left hand, with right hand holding lead strap about twelve inches (12") from horse's head while leading.
7. Ability to follow directions in order to complete class routine or pattern.

Suggestion: If asked to turn, handler to turn into horse's head. Horse should be led straight to the judge and straight away from the judge (at the option of judge's routine or pattern). Visiting or chewing gum should be severely penalized.

Tandem Bareback – Hats not required

To be shown at a walk, trot or pleasure gait and lope. Judged on poise, balance and ease in riding bareback and ability to show good horsemanship as a unit. Teams are to be comprised of male and female, two (2) males or two (2) females.

Judging to consist of:

- Forty (40) percent ability to ride as one (1)
- Twenty-five (25) percent horsemanship
- Twenty (20) percent performance
- Fifteen (15) percent matching attire

No chaps allowed.

Trail Horse

This class will be judged on the performance of the horse at the three (3) gaits, performance over the obstacles, response to the rider, and intelligence.

Horse to be shown at a walk, trot or pleasure gait and lope (on correct leads) with a reasonably loose rein and without undue restraint. Excessive speed is to be penalized. The judge shall have the right to ask for additional work of this same nature from any horse.

Six (6) or seven (7) obstacles will be used; three (3) of which will be mandatory and three (3) or four (4) others selected from the list of suggested additional obstacles. The gait between obstacles shall be

at the discretion of the judge.

A. Mandatory obstacles are:

- 1) Opening, passing through, and closing gate. (Use a gate which will not endanger horse or rider.)
2. Ride over at least four (4) logs.
3. Ride over wooden bridge.

B. Suggested additional obstacles are:

1. Water hazard (ditch or shallow pond).
2. Hobble or ground tie horse.
3. Carry or drag object from one (1) part of arena to another.
4. Back horse through "L" shaped course.
5. Put on and remove slicker.
6. Dismount and lead horse over obstacles not less than fourteen inches (14") high or over twenty-four inches (24") high.
7. Send horse freely into horse trailer.
8. Three hundred sixty (360) degree turn in a box or other defined area.
9. Side passes over a log or pole on the ground.
10. Back, walk or trot through two (2) cones or barrels, around a third and back through the two (2) original cones or barrels.
11. Open and close a mailbox. Rider may take an object from and/or place an object in the mailbox.

Only one (1) hand may be used on reins and hands must not be changed, except that it is permissible to change hands to work with an obstacle. Hand to be around reins. One (1) finger between reins permitted.

- a) While horse is in motion, rider's hands shall be clear of horse and saddle.
- b) Spurs or romal shall not be used forward of the cinch.

Horse shall be shown with a stock saddle. Silver equipment will not count over a good working outfit.

The judge has the option to ask only the finalists to work on the rail or additional obstacle work. Rail work to be walk, trot or pleasure gait and lope both ways of the ring with reasonable loose rein and without undue restraints. Excessive speed to be penalized. Additional obstacle work at the discretion of the judge.

Walk Trot

Walk Trot class to be judged either as a pleasure or horsemanship class.

Western Riding

Western Riding is neither a stunt nor a race. It is a competition in the performance of a sensible, well mannered, free and easy moving horse which can get its rider around on the usual ranch chores, over the trails, or give a quiet, comfortable and pleasant ride in open country through and over obstacles.

The contesting horses will be judged on riding qualities of gaits (walk, trot or pleasure gait and lope), change of leads, and response to the rider, manners, disposition, and intelligence. Any western equipment

of the exhibitor's choice may be used, but the kind of equipment apparently necessary for control of the horse – such as severe bit, spurs, etc. – may be considered by the judge in scoring. No nose bands or tie downs will be permitted. Extra credit will not be given for expensive or fancy equipment for horse or dress for the rider.

The following pattern and routine are prescribed. It is essential that judge and exhibitors adhere to it.

- a) On the pattern, the short, double line represents a swinging gate which the horse must put the rider in a position to open, pass through, and close without dismounting. It may be located in any part of the arena and should be one which will not endanger horse or rider.
- b) The eight (8) small x's represent markers (barrels, kegs or standard recommended). These should be separated by a uniform distance of not less than thirty feet (30') nor more than fifty feet (50')
- c) The rectangle represents an obstacle (one (1) small log recommended) just high enough to break the animal's stride.
- d) The long and sometimes twisting line indicates the direction to travel and the gaits at which the horse is to move. The dotted line (...) indicates the walk, the dash line (----) the trot or pleasure gait and the solid line (____) the lope.

The exhibitor will put his horse through the gate and then proceed on the routine as indicated by the pattern. On completion, he/she will ride to the center of the pattern and back the horse as indicated by the judge. Any horse not following exact pattern will be disqualified.

The judge may require an exhibitor to repeat or reverse any part of the routine.

Only one (1) hand may be used on reins and hands must not be changed, except that it is permissible to change hands when opening gate, if the gate is in such a position as to justify a change of hands on the reins.

Hand to be around reins. One (1) finger between reins permitted.

- a) While horse is in motion, rider's hands shall be clear of horse and saddle.
- b) Spurs or romal shall not be used forward of the cinch.

WESTERN RIDING PATTERN

	GATE		WALK
	LOG		TROT
	MARKER		LOPE
			BACK

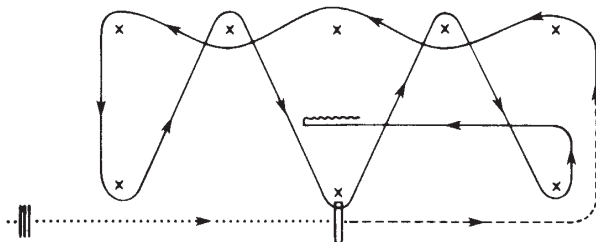

JUMPING DIVISION

Working Hunter, Hunter Hack, Jumping

General: Arrangement of the jump course will be at the discretion of the show committee, keeping in mind the abilities of the contestants. It is strongly recommended that show committees putting a jumping division in their show contact someone knowledgeable in setting up a course by contacting the United States Equestrian Federation (USEF) and asking for assistance. If a description of the course, including height of fences, is not published in the show bill, it should be posted at least one (1) hour before the scheduled time of the class. Whenever possible, a schooling area should be provided with at least one (1) practice jump.

In jumping classes no horse may enter the arena until the course and judges are ready. However, riders may be permitted to inspect course on foot prior to the commencement of the class at the discretion of the show committee.

Working Hunter

SUGGESTION: A.S.T.M. (American Society of Testing and Materials) approved helmets are recommended.

A hunter course shall be any course which management deems a fair test of a hunter, but judges are responsible for correctness of each course after it has been set, and shall call the show committee's attention to any errors that would tend to result in unfair or inappropriate courses.

Course or arena management:

- a) Minimum of four (4) obstacles; horses are to make a minimum of eight (8) jumps and a minimum of one (1) change of direction is recommended.
- b) Types of obstacles which may be used:
 - 1) Fences shall simulate obstacles found in the hunting field – such as post and rail, brush, stone wall, chicken coop, Aiken, hedge, etc. A pole over brush and jumps such as triple bar and hog backs are permitted.
 - 2) The top element of all fences must be securely placed so that a slight rub will not cause a knock down.
 - 3) Obstacles should be located forty-eight feet (48'), sixty feet (60') or seventy-two feet (72') apart if room permits (exception – combinations).
 - 4) Height of obstacles must be a minimum of two feet six inches (2'- 6") unless ring conditions (such as muddy or slippery footing) dictate lower heights for safety reasons.
 - 5) The use of wings on obstacles in hunter classes is recommended.

Scoring:

- a) To be judged on performance and manners, with preference shown to the horses covering the course with free flowing strides and which jump the fences from these strides without interrupting the rhythm. (Among horses maintaining this rhythm, preference should be given to those which meet the fences squarely and not at an angle, and to jumping at the center of each fence.) Upon completion of entire class over fences, the finalists will jog, dismounted, past the judges for soundness in order of performance. Finals to include at least nine (9) horses, if available.

- b) Judges shall line up horses on merit of performance before considering soundness.
- c) Soundness: All horses must be serviceable sound. Any horse showing lameness, broken wind, or impairment of vision shall be refused an award.
- d) Horses shall not be required to re-jump the course.

Faults:

- a) Hind knock downs, not the fault of bad jumping shall not necessarily eliminate a horse from an award but shall be scored against it in a comparative manner.
- b) General:
 - 1) When a horse makes two (2) faults at one (1) obstacle only the major fault will be counted, except refusals, which will count in addition.
 - 2) When an obstacle is composed of several elements in the same vertical plane, a fault at the top element is the only one (1) penalized.
 - 3) When an obstacle requires two (2) or more fences (in-and-out) the faults committed at each obstacle are considered separately. In case of a refusal or run out at one (1) element entry may re-jump the previous as well as the following elements.
 - 4) Judge shall emphasize unsafe jumping and bad form over fences, whether touched or untouched.
- c) Touches: Light touches are not to be considered but may be scored according to scale below for reference in cases where elimination is difficult.
 - 1) With any part of horse's body behind the stifle...half (1/2) fault
 - 2) With any part of horse's body in front of the stifle...one (1) fault.
 - 3) Of standard or wing in jumping obstacle with any part of horse, rider or equipment...one (1) fault
- d) Knock downs: Including faults at Liverpool (major faults). An obstacle is considered knocked down when its height is lowered by horse or rider.
 - 1) With any part of horse's body behind the stifle...four (4) faults
 - 2) With any part of horse's body in front of the stifle...eight (8) faults
 - 3) Of standard or wing in jumping obstacle with any part of horse, rider or equipment...eight (8) faults
 - 4) Of obstacle by touching a wing or post, it shall count as a knock down obstacle with above penalties
 - 5) Placing any foot in Liverpool, ditch or water...eight (8) faults
 - 6) Hind knock downs, not the fault of bad jumping shall not necessarily eliminate a horse from an award but should be scored against in a comparative manner.
 - 7) When a horse touches an obstacle, causing a rail of an adjoining panel or wing to fall, it shall not be construed as a knock down.
- e) Disobedience (major faults): Circling once upon entering the ring and once upon leaving is permissible.
 - 1) First refusal (see definition of disobediences under jumping), run out, bolting on course, extra circle....eight (8) faults
 - 2) Second refusal, run out, bolting on course, extra circle... eight (8) faults

- 3) Third refusal, run out, bolting on course, extra circle or any combination of these...elimination
- 4) Jumping an obstacle before it is reset...elimination
- 5) Bolting from ring....elimination
- 6) Failure to keep proper course...elimination
- 7) Jumping an obstacle not included in course.....
elimination
- f) Falls: Horses and/or rider fall in competition.....elimination. A horse is considered to have fallen when shoulder and haunch on the same side touch the ground or the obstacle and the ground.

Equipment and Personal Appointments: Personal, tack, optional, and prohibited appointments same as in jumping class, excepting leg wraps not permissible.

Hunter Hack:

SUGGESTION: A.S.T.M. (American Society of Testing and Materials) approved helmets are recommended

- a) Horses will be shown at a walk, trot or pleasure gait and canter both ways of the ring. All horses will be required to jump two (2) jumps three feet (3') maximum in height each. The top eight (8) horses, if available, are to hand gallop one (1) way of the ring.
- b) The class will be judged on an even hunting pace, manners, way of going and jumping style. Ticks and jumping faults will be scored as in the working hunter class. These may be used at the discretion of the judge to place his/her class.
- c) Tack and equipment and the attire of the rider shall be the same as in the working hunter class.

Jumping:

SUGGESTION: A.S.T.M. (American Society of Testing and Materials) approved helmets are recommended

Arena arrangement:

- a) There will be a minimum for four (4) obstacles; horses are to make a minimum of eight (8) jumps.
- b) Type of obstacles which may be used: (it is recommended that first obstacle should be no more than minimum height)
 - 1. Post and rail (at least two (2))
 - 2. Chicken coop
 - 3. Stone wall
 - 4. Triple bar
 - 5. Brush jump
- c) Both a starting line at least twelve feet (12') in front of the first obstacle and a finish line at least twenty-four feet (24') beyond the last obstacle must be indicated by markers (at least twelve feet (12') apart) at each end of the lines. Horse must start and finish by passing between markers.
- d) Obstacles (except within combinations) should be located a minimum distance of forty-eight feet (48') apart, size of arena permitting.
- e) Height of obstacles shall be a minimum of thirty-six inches (36") unless ring conditions (such as muddy or slippery footing) dictate lower height for safety reasons. Only in case of clean round ties, for first place or when points are involved, rails shall be raised not less than three inches (3") nor more than six inches (6") for each jump off. (In case of ties involving faults, rails shall not be raised.) When second jump off is required, the winner will be

- decided on time only if faults are equal.
- f) The course to be used must be posted at least one (1) hour before scheduled time of class.
 - g) Whenever possible, a schooling area should be provided with at least one (1) practice jump

Scoring:

- a) Jumpers are scored on a mathematical basis and penalty faults, which include knock downs, disobediences and fails.
- b) Knock down: when a horse attempts to jump an obstacle and knocks down the obstacle or any portion of it, standard, or wing with any portion of the horse, rider, or equipment, it is considered a knock down and is given four (4) faults (with exception listed in note below).
NOTE: When a horse knocks down all or a portion of an obstacle while refusing, it is not to be faulted for a knock down, but should be given only the correct amount of faults for that refusal.
- c) Disobediences
 1. Refusal: when a horse stops in front of an obstacle (whether or not the obstacle is knocked down or altered) it is a refusal unless the horse then immediately jumps the obstacle without backing even one (1) step; but if horse takes even one (1) step backwards, it is a refusal.
 - a) If horse is moved toward obstacle after a refusal without attempting to jump, it is considered another refusal.
 - b) In the case of a refusal on an in-and-out jump, the horse must return to the start of the in-and-out sequence and re-jump the previous elements as well as jump the following elements.
 2. Run-out. A run-out occurs when a horse evades, or passes the obstacle to be jumped; jumps an obstacle outside its limiting markers; or when horse or rider knocks down a flag, standard, wing or other limiting the obstacle (without obstacle being jumped).
 3. Loss of forward movement. Failure to maintain trot or pleasure gait, canter or gallop after crossing starting line (except when it is a refusal, a run-out, or when due to uncontrollable circumstances such as when an obstacle is being reset) is disobedience.
 4. Unnecessary circling on course. Circling once upon entering the ring and once upon leaving is permissible. Any additional circling on course or unnecessary showing of fence to horse is disobedience.
 5. First disobedience (anywhere on course) three (3) faults.
 6. Second disobedience (anywhere on course) six (6) additional faults.
 7. Third disobedience (anywhere on course) elimination.
- d) Fall of horse and/or rider, elimination.
- e) Failure to complete course, off course, elimination.
- f) In cases of broken equipment, the rider may either continue without penalty or stop and correct difficulty, in which case, he/she will be penalized three (3) faults. In case of loss of shoe, rider may either continue without penalty or be eliminated.

Equipment and Personal Appointments:

- a) Personal appointments (required): Suitable show hunter riding coat (tweed or solid wools and/or summer weight solids or conservative patterns). Hard hunting hats (caps or derbies) mandatory. Choice of britches and high English boots or jodhpurs and Jodhpur shoes. Stock, tie or choker is required. Hair must be neat and contained (as in net or braid).
- b) Tack appointments (required): English snaffle (no shank). Pelham (with two (2) reins), kimberwick and/or full bridle all with cavesson nosebands and plain leather brow bands. Any deviation from regulation bits is prohibited. Saddle: Hunting or forward seat; may have suede seat and/or suede insert on skirt.
- c) Optional appointments: Spurs of the unrowelled type, crops, bats, gloves or English breast plate, and braiding of mane and/or tail in hunt style, martingales, leg wraps and boots are all optional.
- d) Prohibited appointments: Draw reins.

EXPLANATION OF CLASSES GAME CLASSES

Balloon Contest

Contestants each have a uniform sized balloon, tied with a twelve inches (12") piece of string on the left arm above the elbow. All entries ride in a circle until the signal is given, then they ride among the other entries and break as many balloons as they can. For safety, riders may only grab balloons or strings and may not pull on another rider's limbs, clothing or equipment.

Bareback Pickup Race – Timed event ~ Hats not required

Rider to be dismounted. At the signal, rider jumps on his/her horse and races to the other end and picks up his/her partner. Distance not to exceed fifty (50) yards between designated starting line and pickup line. Rider to be picked up behind pickup line. Both riders must be mounted astride the horse crossing the finish line. Once the horse crosses the pickup line, riders must not touch the ground before the finish line. Horse may be used only once. Contestants may enter the ring twice (may ride twice, may be picked up twice or may ride once and be picked up once.)

Cloverleaf Barrel Race – Timed event

Any barrel listed under approved safety equipment may be used. Rider may enter the pattern from right or left side.

- a) Barrel horse to be used only once per event.
- b) Twenty-one feet (21') or more running start. No circling through the pattern before starting the run. Infractions of rules mean disqualification.
- c) The first two (2) barrels to be placed twenty-one feet (21') or beyond from the time line.
- d) Two (2) handed ride permitted.
- e) Touching or steadying of approved safety equipment with hand or a knock down of equipment means disqualification, except when the event states differently.

Suggestion: Extend the barrels out to a size compatible with the size of the arena and allow a safe distance from the fence. Safe distance: Recommended as 21' or more. In pony barrels, barrels should be set up suitable for the size of ponies.

BARREL PATTERN

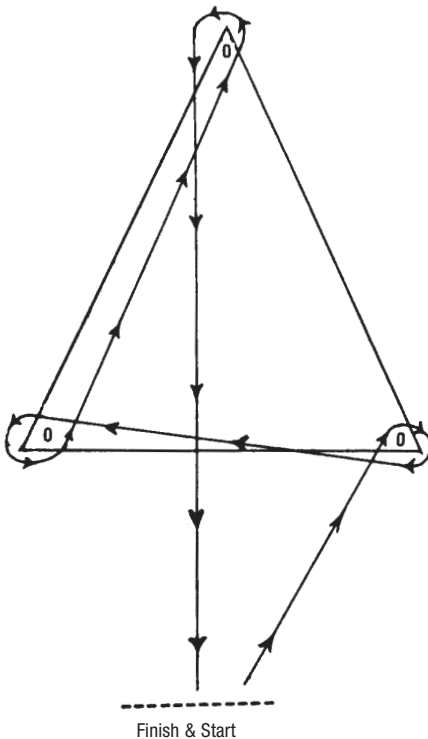

Rider may enter from right or left side.

Bat Race – Timed event ~ Hats not required

- a) Rider to start from a starting line and race approximately two-thirds of a set distance.

- b) Number of riders to compete at one (1) time to be left up to the discretion of the horse show committee.
- c) Fifteen feet (15') distance between riders
- d) At two-thirds distance, a horse holder will be stationed, at a marked area and is not to leave this area. Rider to dismount and give his horse to horse holder and run to bat.
- e) Upon reaching bat, contestant will place his hands and forehead on a baseball bat and turn around as fast as he can nine (9) times, keeping the other end of the bat on the ground.
- f) Runs back to his horse, mounts and races back to starting line.
- g) The person holding the horse is not to help rider back on but is to hold the horse until he is safely mounted.

Boot Scramble

All contestants' boots to be placed at far end of arena in a pile. At a signal they are to race down, get their boots on, and ride back to finish line. Judge to place winners as they cross line.

Cow-Hide Race (See Scoop Shovel Race)

Egg and Spoon (Game event)

Eggs to be balanced on teaspoons. Spoons held with one (1) hand with no fingers or supports used to balance the egg. Horses to be shown at gaits specified by the judge.

- a) Use of show committee eggs and spoons only.
- b) Spoons to be uniform.
- c) Spoons in contestant's mouth prohibited.
- d) Dismounting off rear of horse prohibited.
- e) No draw reins or facsimile, purchased or homemade, may be used.
- f) Reins cannot be tied to the saddle horn.

Equipment Race

Western blanket, western saddle and western bridle having chin strap and bit are placed at ten foot (10') intervals in that order from the far end of the ring towards the finish line. Using only halter and rope, rider rides horse from starting line to the far end of the ring, where he/she dismounts and tacks up horse. Bridle may not be put on over the halter. Cinch must be reasonably tight and fastened with two (2) loops of latigo and tied in the standard method of western cinching. After completely tacking up the horse, rider mounts and races to the finish line. Rider must bring back the halter and rope as he/she races to the finish line.

Figure Eight Race

Four (4) poles. Two (2) separate courses, two (2) poles each. Riders execute two (2) figure eights each around the poles. First one back to the starting, finishing line is the winner. The other is eliminated, run this two (2) at a time until only six (6) are left. Those six (6) run one (1) at a time and are timed. One with the best time is first, etc.

Suggestion: A fair way to run this is to take the names two (2) at a time just the way they are entered on the sheet.

Or: Contestants may run one (1) at a time, to be timed individually. Pattern: Two (2) poles, first pole to be twenty-one feet (21') from time line, second pole to be extended according to ring size. Rider must execute two (2) figure eights around poles.

Touching or steadying of approved safety equipment with hand or a knock down of equipment means disqualification, except when the event states differently.

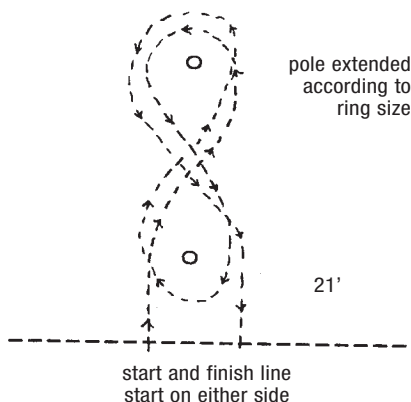

Flag Race – Timed event

Two (2) barrels are to be placed seventy-five feet (75') apart. A pail placed on top not to exceed five (5) gallons filled with sand or soil of a similar consistency (two (2) inches from the top). Pennants to be approximately half inch (1/2") diameter and twelve inches (12") inches to eighteen inches (18") in length. Flag to be approximately six inches by eight inches (6" x 8"). The first barrel to be twenty-one feet (21') from the start. Two (2) flags of one (1) color must be in one (1) pail and two (2) flags of another color in the other pail. The rider starts by taking one (1) of the flags from the first pail, puts it in the second, takes a flag from the second pail and puts it in the first. He/she continues until the flags are reversed. Texas Flag and Pennant Race also listed in book. Touching or steadying of approved safety equipment with hand or a knock down of equipment means disqualification, except when the event states differently. Any barrel listed under approved safety equipment may be used. See equipment requirements.

Four in Line

Four (4) contestants to a team. Horses go through pattern one (1) behind the other. Must start, progress and finish in same order. Five (5) second penalty for tipped marker. Pattern may be started from the right or the left. Pattern shall consist of four (4) barrels placed twenty-one feet (21') apart beginning twenty-one feet (21') feet from the start line. Three additional barrels shall be placed as follows: one (1) on each side of the last of the four (4) barrels and co-linear with it; the distance between that barrel and each of the other two (2) barrels is at least twenty-one feet (21'). The third barrel is placed in line with the four (4) at least thirty six feet (36') beyond the fourth. The distance beyond the thirty-six feet (36') should be appropriate to the size of the arena. No marker may be closer than twenty-one feet (21')

from any arena fence. The team will weave the first four (4) barrels, ride the perimeter of the three (3) barrel pattern and weave back. (See diagram attached.) Touching or steadying of approved safety equipment with hand means disqualification. Any barrel listed under approved safety equipment may be used.

Suggestion: Hand timers to be used, timing nose of first horse in, and nose of last horse out.

FOUR IN LINE

Suggestion: Please note that the three (3) barrels in a triangular pattern may be extended.
Note: "minimum".

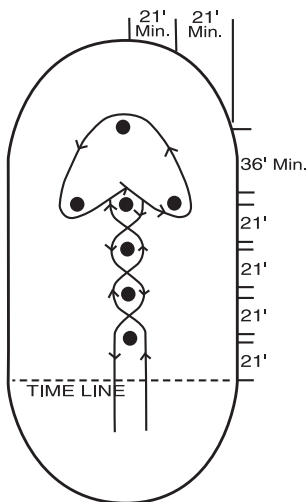

Goat Tying – Timed event

Goat to be staked at far end of the arena on a rope, approximately ten feet (10') long. Contestant is allowed a rope approximately four feet (4') in length (know as a piggin' string). Contestant rides to the horse holder, dismounts, throws the goat by hand, and ties any three (3) legs. Must stay tied for five (5) seconds. Horse holder to be in marked area. Piggin' string or leather thong to be furnished by show committee or contestant may use his/her own piggin' string.

Jumping Figure 8 – Timed event

A plastic pole (in accordance with safety committee regulations) is set on standards, a minimum of twelve inches (12") and a maximum of eighteen inches (18") off the ground and twenty-one feet (21') past the starting line. Three (3) barrels are placed parallel to the starting line and are to be twenty-one feet (21') apart, between barrels. Contestant is to pass the starting line, jump the pole, and complete a double figure eight around the barrels (see diagram), return and jump pole, and cross finish line. Touching or steadying of approved safety equipment with hand or a knock down of equipment means disqualification, except when the event states differently. Any barrel listed under approved safety equipment may be used.

JUMPING FIGURE EIGHT

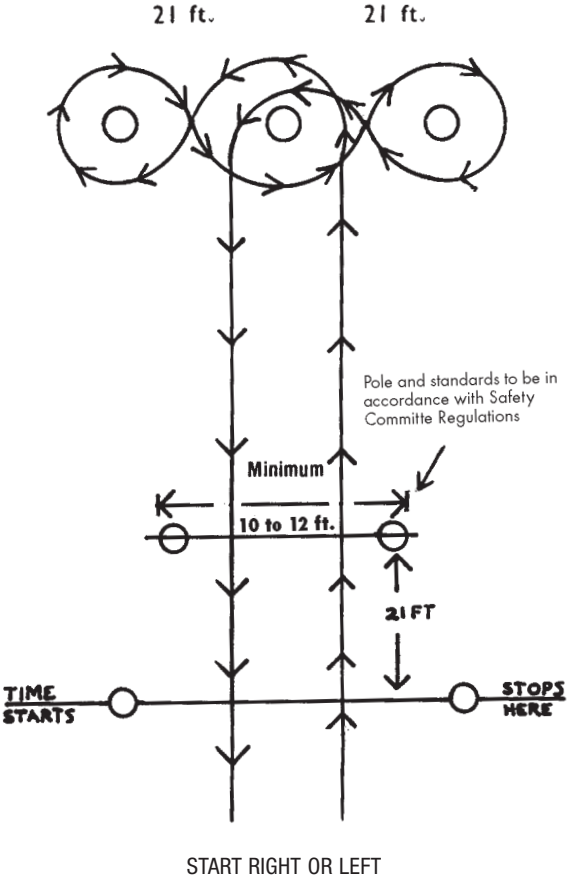

Key Hole Race – Timed event

A diagram of a key hole is drawn out with bailing twine or lime on the ground. The key hole has the following dimensions. The entrance way should be four feet (4') by ten feet (10') and the circle twenty feet (20') in diameter. Contestant races at least one hundred feet (100') from starting line to entrance way of key hole. The rider must race down, enter key hole through entrance way, turn within the circle and race back through the entrance way, and to the finish line. Should the horse at any time **cross** any line of the key hole, disqualification results.

Key Race – Timed event

- a) (Identical to Key Hole Race) except for entrance – **Poles** are used – no chalk necessary. Three (3) poles on each side of entrance. Opening – four feet (4'), length – ten feet (10'). Touching or steadying of approved safety equipment with hand or a knock down of equipment means disqualification, except when the event states differently.

Musical Tires or Sacks

- a) Horses must be in counter clockwise direction at a **moderate canter** at all times, no doubling back or weaving.
- b) Rider must not cut back more than the length of his/her reins after the music stops (seven feet (7') rein maximum).
- c) Rider must not cut between a dismounted rider and his/her horse.
- d) Riders must stay outside pattern.
- e) All passing must be to right of horse and rider. Riders must leave passing room on the right hand side.
- f) Rider must not cut inside of corner barrels.
- g) Person stopping music must be relatively alone and blindfolded. No one may be watching class and stop music on his/her own accord.
- h) Music to be stopped until only three (3) riders remains. These three (3) remaining riders to run off in the following manner: Each rider to have a tire or sack placed not to exceed fifty (50) yards from them. Horses to be faced in an opposite direction from the tires or sacks. Upon a given signal rider to turn horses and race for their respective tire or sack. First one properly positioned to be the winner.

Modified Musical Tires or Sacks

- a) Tires to be placed in line down center of arena.
- b) One (1) barrel on each corner. Riders have to go around outside of barrel. Any barrel listed under approved safety equipment may be used.
- c) When music stops rider must stop his/her horse where he/she is.
- d) Rider must stay outside pattern. Touching or steadying of approved safety equipment with hand or a knock down of equipment means disqualification, except when the event states different.
- e) Must lead his/her horse into center row of tires and claim one (1).
- f) Not to mount his/her horse again until music starts.
- g) Continue on until only three (3) riders' remains. These three (3) remaining riders to run off in the following manner: Each rider to have a tire or sack placed not to exceed fifty (50) yards from

them. Horse to be faced in an opposite direction from the tires or sacks. Upon a given signal, riders to turn horses and race for their respective tire or sack. First one (1) properly positioned to be the winner.

Monkey in the Tree – Timed event ~ Hats not required

Tandem riders begin the pattern either the right or left. Race around marking poles/barrels to suspended tire at far end of the ring. Leave "Monkey", or rear rider, hanging on tire. Remaining rider makes a complete circle around marking poles/barrels, picks up suspended rider and exits through timing poles. Both riders to be mounted astride the horse, crossing the finishing line. "Monkey" must be mounted behind the saddle. At no time, can "Monkey" touch the ground between the start line and the finish line. Touching or steadying of approved safety equipment with hand or a knock down of equipment means disqualification, except when the event states differently.

Package Race

Contestants to line up on far end of arena. When given signal, race to the other end, unwrap package in front of them, put on all wearing apparel in package and race back to starting line. To be placed as they cross the line.

Pennant Race – Two (2) Barrel – Timed event

- a) Rider must take flag from first pail (not to exceed five (5) gallons), ride down to the other barrel, put the flag up, take other color flag, and ride back to other barrel and put flag up.
- b) Contestant must enter on one side of barrel and exit on the other side.
- c) Barrels to have pails filled with sand or soil of similar consistency (two (2) inches from top). If flag falls over but stays in the pail, contestant time counts.
- d) If flag falls out of pail or ride knocks over barrel there is no time.
- e) Distance to be determined by size of arena.
- f) Pennant not to exceed half inch (1/2") in diameter and twelve (12) inches to eighteen (18) inches in length. Flag to be approximately six inches by eight inches (6" x 8").
- g) Touching or steadying of approved safety equipment with hand or a knock down of equipment means disqualification, except when the event states differently.
- h) Any barrel listed under approved safety equipment may be used.
- i) Cannot hit the horse with pennant.
- j) Pennant straightened after each run.

Pennant Race – One (1) Barrel – Timed event

See also in this book Texas Flag Race and Flag Race.

- a) One flag is placed in pail, not to exceed five (5) gallons, filled with sand or soil of similar consistency, two inches (2") from top of pail. Pail is placed on barrel at far end of the arena. (Distance determined by size of arena.)
- b) Rider takes starting flag, rides to barrel, puts flag in pail, picks up other color flag and rides back across finish line.
- c) If flag falls over but stays in pail, contestant time counts.
- d) Contestant must enter on one side of barrel and exit on the other side.

- e) Cannot hit the horse with pennant.
- f) Pennant straightened after each run.
- g) Pennant to be approximately half inch (1/2") in diameter and twelve (12) inches to eighteen (18) inches long. Flag to be approximately six inches by eight inches (6" x 8").
- h) Touching or steadying of approved safety equipment with hand or a knock down of equipment means disqualification, except when the event states differently.
- i) Any barrel listed under approved safety equipment may be used.

Pole Bending – Timed event

- a) Six (6) poles, twenty-one feet (21') apart. First pole twenty-one feet (21') from the time line. Poles to be as specified by Safety Committee Regulations.
- b) Twenty-one feet (21') or more running start. Contestants are not to be allowed to go past the area of the imaginary starting line. No circling through the pattern before starting the run. Violation of above rules results in disqualification.
- c) Two (2) handed ride optional.
- d) May start from either right or left side.
- e) Touching or steadying of approved safety equipment with hand or a knock down of equipment means disqualification, except when the event states differently.

Pole Weaving – Timed event

Same directions as Pole Bending, except start weaving at first pole. (See diagram)

Pole Bending (Team) – Timed event

- a) Poles and distances same as single pole bending.
- b) Two (2) riders. Must maintain hand-hold throughout course or be disqualified.
- c) Same rules as Pole Bending.

see diagram on following page

POLE BENDING

There are six (6) poles, twenty-one (21) feet apart. The contestant will have a twenty-one (21) foot or more running start. This is a timed event.

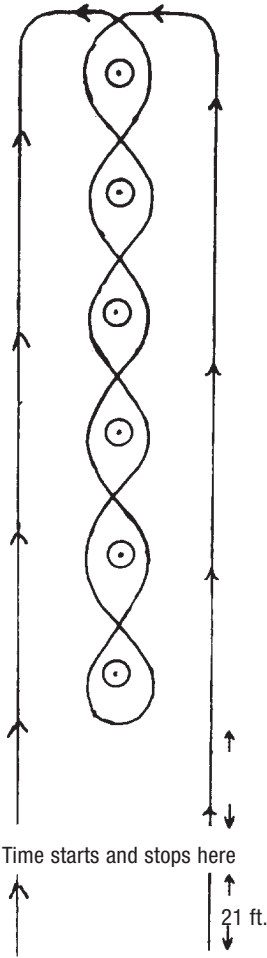

WEAVING POLES

The contestant will have a twenty-one (21) foot or more running start. This is a timed event.

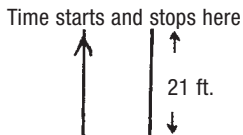

Pony Chariot Barrel Race – WSCA Pattern – Timed event (see diagram)

Any barrel listed under approved safety equipment may be used. Suggest extending the barrels out to a size adequate to the size of the arena. In pony barrels, barrels should be set up suitable for size of ponies. Driver may enter the pattern from right or left side.

- a) Chariot team to be used only once per event.
- b) Suggested twenty-one feet (21') or more running start. Contestants are not allowed to go past the area of the imaginary starting line, no circling through the pattern before starting the run. Infractions of rules means disqualification.
- c) Two (2) handed drive permitted.
- d) Touching or steadying of approved safety equipment with hand or a knock down of equipment means disqualification, except when the event states differently.
- e) No use of whips.
- f) Hats not required.

PONY CHARIOT BARREL RACE

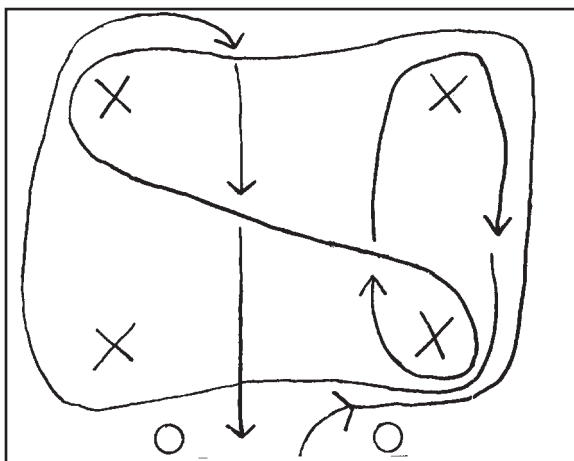

Pony Chariot Rescue Race – (See Diagram) – Timed event – Hats not required

A pony may be entered no more than once in this event. Contestant may enter the ring twice. (May drive twice, be picked up twice or drive once and be picked up once.) Distance not to exceed fifty (50) yards between the designated starting line and designated pickup line. Contestant to be picked up behind pickup line. Once the pony passes the mounting line, the pick up and driver must not touch the ground before the finish line.

Each event to have two (2) classes of ponies – forty-eight inches (48") and under, over forty-eight inches (48") up to and including fifty-two inches (52"). A team can only run in one (1) class.

see diagram on following page

PONY CHARIOT RESCUE RACE

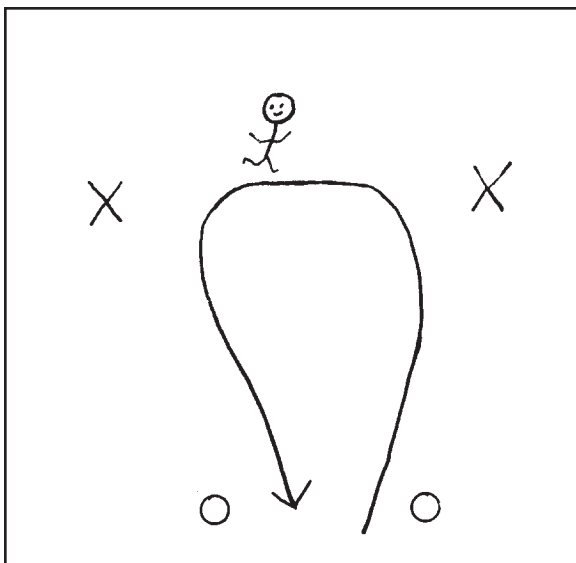

Pop Race

Use one (1) bottle of pop per contestant. Pop to be all of one (1) kind. Contestants' races to far end of ring, dismount, and drink all of pop in bottle, mount and race to finish. **OR**, as a team race – two (2) riders, each with his/her own horse, constitute team. One (1) rider carries pop, partner is stationed at far end of ring and holds bottle opener. First rider races to partner who opens and drinks pop while on ground. Then he/she mounts and both riders race holding hands to finish. Bottle must be returned.

Potato Race

- Contestants in a line facing away from pile of potatoes
- Potatoes to be fifty (50) yards from container
- Rider must dismount to pick up potatoes, one (1) at a time. May remain mounted to deposit potatoes in container. In the event of missing the container, the rider must immediately dismount (both feet on the ground) and place missed potato in container.
- Two (2) minutes time allowed. Potatoes to be counted and contestants to be placed accordingly.
- After time has been called all riders shall retire ten feet (10') behind their containers. Any potatoes put in container after time has been called shall not be counted.

Relay Race – Timed event – Hats not required

One (1) rider to race his/her horse to other end and dismount. His/her partner to mount and ride back to finish line. Once you pass the mounting line, the rider must not touch the ground before the finish line. Contestant may enter the ring twice, may (ride and be picked up) or (ride twice, using a different horse) or (be picked up twice). Touching or steadying of approved safety equipment with hand or a

knock down of equipment means disqualification, except when the event states differently.

Relay Race – Team – Timed event

Two (2) horses: both horses begin behind the time line. Rider one (1) goes all the way around the four (4) barrels or poles. Rider two (2) beings. The baton is passed while the riders are between the two (2) pylons or poles on the rail. Rider two (2) completes the circle and crosses the finish line. None of the four (4) barrel or pole markers shall be less than twenty-one feet (21') from any rail. Touching or steadying of approved safety equipment with hand or a knock down of equipment means disqualification, except when the event states differently. The pylon or pole markers shall be approximately forty-eight feet (48') apart. Any barrel listed under approved safety equipment may be used.

Three (3) horses: horse two (2) goes to inside after passing baton to rider three (3) who then completes the circle and crosses finish line.

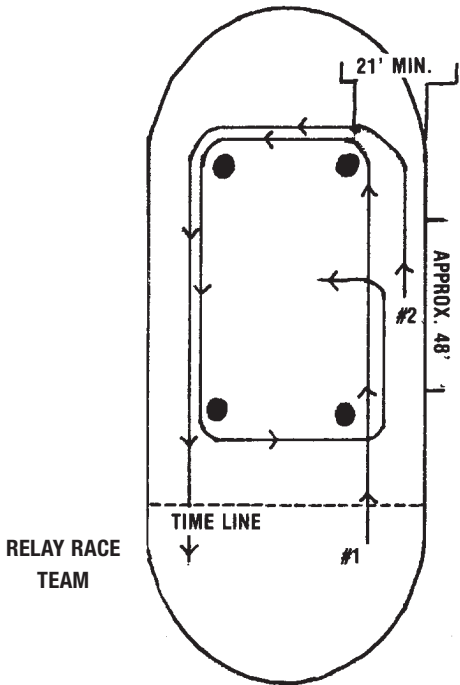

Rescue Race – Timed event – Hats not required

A horse may be entered no more than once in this event. Contestant may enter the ring twice. (He may ride twice or be picked up twice OR ride once and be picked up once.) Distance not to exceed fifty (50) yards between designated starting line and designated pickup line. Jump man must remain behind the pickup line after the time is started. Jump man must be picked up behind the pickup line. Once the horse passes the pickup line, neither the jump man nor the rider may touch the ground before the finish line. Both riders must be astride the horse when the finish line is crossed.

Ribbon Race – Timed event

- a) Crepe paper ribbon eighteen inches (18") long, approximately two inches (2") wide.
- b) Riders to each hold one (1) end of ribbon, ride to other end around barrel then back across finish line.
- c) No arm or finger locking.
- d) Touching or steadying of approved safety equipment with hand or a knock down of equipment means disqualification, except when the event states differently.
- e) Any barrel listed under approved safety equipment may be used.

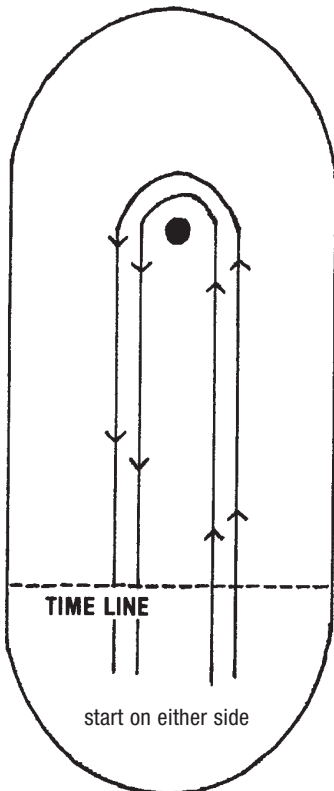

RIBBON RACE

Ride A Buck – Game event

The horse is to be ridden bareback with a dollar bill or piece of paper the size of a bill under the rider's leg. No chaps are to be worn and the rider's free hand should be visible and not touching the horse or hanging on to the mane. The gaits are at the discretion of the judge.

Ring Race – Timed event

The object is to see how many rings a rider can spear from horseback while running a circular course in an arena. There are six (6) rings in all, three (3) on each side of the arena. Spear the rings with a tapered stick of wood, approximately thirty inches (30") long, to which a wood or plastic shield is attached about eight inches (8") from the base, or holding end. This catches the rings as they are speared. (A cut-down billiard cue makes a good spear.) Time starts when the horse's nose reaches the starting line and end when the horse's nose reaches the finish line. A one (1) second penalty is added to a contestant's time for each ring that is missed. A rider must spear two (2) rings to qualify. The rider is disqualified if he/she used the spear to hit his/her horse or if the spear is held farther than eight inches (8") from the base end. The rings must remain on the contestant's spear or arm until he/she completes the ride. Must complete full course of pattern. Riders can circle the pattern in either direction. (To keep this event moving rapidly, someone should be behind each ring support to replace the rings as they are speared.)

Equipment for Ring Race: rings used in this contest are plastic, preferably all the same color, and about five inches (5") in diameter. They are suspended just inside the arena by the use of a two inch by four inch (2" x 4") over hanging arm which is attached to an upright post along the arena's edge. (This arm could be put on a hinge so that it folds back off the arena when not in use.) The over hanging arm should extend into the arena about twenty inches (20"). Nail a piece of leather or rubber strap that hangs down twelve (12) – fourteen (14) inches from the arm. A clothespin attached to the end of the strap will hold the plastic ring securely until speared by the passing rider. The rings should be shoulder height to the average person on horseback. The over hanging arms should be above head height to avoid the chance of an accident. The strap that hangs down should have a buckle in it so that the height of the ring can be adjusted in case one class is for younger riders or class with pony riders, etc. The rings are spaced about fifteen (15) yards apart with the first and sixth rings placed thirty feet (30') from the starting-finish line.

Sacks – (See Musical Tires)

Scoop Shovel Race or Cowhide Race – Timed event

A large scoop shovel or cowhide is to be used. One (1) partner sits on the shovel facing the horse. Rope may be dallyed on either or both ends. At least one (1) dally must be used – team's choice. Thirty foot (30') rope required. At the signal he/she will race to whatever pattern the show committee has set up – either a line of one hundred feet (100') or perhaps a large circle. For safety the rider must be able to leave rope free at any time. A contestant may enter the ring twice (may ride twice, may be picked up twice, or may ride once and be picked up once.) Horse may be used only once.

Scudda-Ho – Timed event

Rider to start on left side of first pole, weave through poles, then down center of arena, over pole jump, over brush jump, and around barrels, then back over the jumps. If jumps are knocked down they are to be replaced by ring crew before the horse returns for second jump. Two (2) seconds to be added on time for knock down of pole, jump or barrel. Tick does not count.

Equipment needed: Four (4) poles and three (3) barrels. Poles and jumps to be as specified by safety committee regulation. Any barrel listed under approved safety equipment may be used. Brush to be attached to poles for brush jump. Jumps are to be no lower than twelve inches (12") and no higher than eighteen inches (18"). Rider is eliminated for bypassing jump or leaving course. Touching or steadying of approved safety equipment with hand or a knock down of equipment means disqualification, except when the event states differently.

There should be at least fifty feet (50') between the last jump and timing line due to difficulty of jumping and turning horse in a shorter distance.

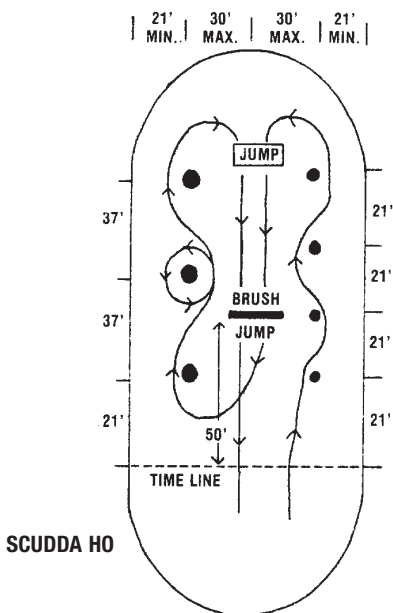

Speed and Action – Timed event

A twelve foot (12') box is made with four (4) poles. A barrel is placed at the far end of the arena. Any barrel listed under approved safety equipment may be used.

No disqualification if horse steps out of the box or knocks over pole before starting run; however, he/she must start run from inside box with all poles standing.

Time starts when horse leaves box and stops when horse's four (4) feet are again in box.

Rider must stay five (5) seconds in box, mounted (judge or other official, with or without stop watch, to count five (5) seconds aloud). Barrel must remain standing.

Running out of box or knocking over pole upon return to the box means disqualification. Touching or steadying of approved safety equipment with hand or a knock down of equipment means disqualification, except when the event states differently.

Speed Dash – Timed event

Any barrel listed under approved safety equipment may be used, centered at far end of arena. Start at timing line, around barrel and run back across finish line. Finish line not to be past exit or entrance gates.

- a) Horse may be used only once per event.
- b) Suggested twenty-one feet (21') or more running start. Contestants not to go past the area of the imaginary starting line before starting their run. Infraction of rules means disqualification.
- c) Two (2) handed ride permitted.
- d) Touching or steadying of approved safety equipment with hand or a knock down of equipment means disqualification, except when the event states differently.

Texas Flag Race – Timed event

Use three (3) flags, approximately six inches by eight inches (6" x 8") of different colors pennants to be approximately one-half inch (1/2") in diameter, two (2) pails filled with sand or soil of similar consistency, two inches (2") from top of pail. Pail should be placed parallel to each other on each side of arena and on a barrel. Any barrel listed under approved safety equipment may be used. They should be thirty (30) yards from starting-finishing line.

To complete the pattern, a barrel is placed in center of arena, about thirty (30) yards from and slightly beyond buckets.

As each contestant enters the arena, he/she is handed first flag. Time starts as horse reaches starting line. Plant the flag in first bucket, grab the flag already there, ride around a barrel to second bucket, change flag there, then ride across finish line. Rider can make circle from either left or right. If flag is dropped, rider must retrieve flag in order to continue. If flag falls over, but stays in bucket, contestant's time counts. Hitting of the horse with flag means disqualification. Touching or steadying of approved safety equipment with hand or a knock down of equipment means disqualification, except when the event states differently.

(There is also Flag and Pennant Race listed in book.)

Trailer Race – Timed event

(The following rules will prevail at the Minnesota State Fair.)

Each club will be limited to one (1) team. The trailer either single or double, carrying a horse wearing only a conventional horse halter. No cow halter, no ropes, leather straps, or other equipment that could be put around the horse's neck, allowed. Trailer to be brought to the center of the ring behind an automobile, pickup or station wagon. The trailers must have drop gates or hinge gates which will operate only from the rear of the trailer with proper fastenings for normal lowering or rising of tailgate. (No pulleys or automatic opening devices allowed.) Double trailers should have a rigid divider, Conventional horse trailer suitable for highway use.

Contestant must go back of trailer to unfasten gate. The back of trailer is to face a given line. A saddle, a saddle blanket (not fastened to saddle), and a bridle are to be placed in front of the vehicle. Horse must face toward front of trailer before race and after race. Any horse turning around in trailer and facing wrong way before time recorded will be disqualified. At the start, the rider and assistant shall stand beside a barrel placed in front of their automobile. When signal to start the race is given, the first of the pair closest to and facing the automobile will start the stop watch on the barrel and then proceed to take the horse from the trailer, remove the halter, and saddle and bridle the horse. One (1) eared bridle or other western bridle without throat latch is allowed. Chin strap or curb chain required. No hackamore bridle permitted. Reins must be on both sides of the horse's neck. Standard western bridle only. No tackaberry permitted. No single strap through ring and half (1/2) hitch around horn permitted. No speed buckles on either side of saddle. Cinch to be fastened with two (2) loops of latigo and tied in the standard method for western cinching. Saddle cinch to be tied and untied by contestant from the ground. No loosening of gear until the contestant gets behind his trailer. The horse is to be ridden to the left three (3) times around the ring. The horse full bridled and saddled with rider up must be brought back to the trailer. The horse is to be unsaddled, unbridled, haltered and put back into the trailer. The end gate must be securely fastened and all the equipment must be put in front of the front tires. Both the rider and assistant must return to the barrel in front of their car, stop the watch. The official judge will record the time on all watches and determine placing on the basis of times recorded. Contestant will be disqualified for infraction of the rules. This is a timed event, fastest time to be the winner. In the final heat at the State Fair, the position of the finalists will be drawn for. Touching or steadying of approved safety equipment with hand or a knock down of equipment means disqualification, except when the event states differently. Any barrel listed under approved safety equipment may be used.

Water Race

Buckets or pans of water are placed at far end of ring, one (1) per entry. Pop or soda bottles at near end on barrels, one (1) per entry. Each entry has one (1) paper cup. Riders race to pails of water, fill paper cup, race back and pour water into pop or soda bottles. First to fill bottle wins. Touching or steadying of approved safety equipment with hand or a knock down of equipment means disqualification, except when the event states differently. Any barrel listed under approved safety equipment may be used.

DRILL AND SQUARE DANCE JUDGING RULES

- 1.0 Order of showing will be determined by drawing lots.
- 2.0 Score Card (Guide for exhibitors and judges).

INSPECTION (JUDGE #1)

- 2.1 Horses
 - 2.1.1 Cleanliness
Horses should be free of dust, dirt and stains
 - 2.1.2 Conformation
 - 2.1.3. Uniformity
Uniform in color, markings and size
 - 2.1.4. Manners / Dispositions
Horses should stand in line quietly

- 2.2 Riders
 - 2.2.1 Cleanliness
Attire should be clean, pressed and within boundaries set by WSCA
 - 2.2.2. Apparel Uniformity
Attire should be uniform and positioned consistently on riders.
 - 2.2.3. Horsemanship
Riders are in control of their horses and reflect basic horsemanship positions for body, hands, legs and feet. Pleasant attitudes should also be displayed.

- 2.3. Tack
Western tack is required. Mixing of equipment shall result in loss of points.
 - 2.3.1. Cleanliness
Tack should be free of dust or dirt and in good working condition.
 - 2.3.2. Uniformity
Tack should be uniform and positioned consistently on each horse. Penalties may be assessed if different tack is used in the arena than shown in during inspection.
 - 2.3.3. Flags
Flags should be cleaned and pressed. Poles should be clean. Flags should be uniform in color and size.

- 2.4 Overall
Is the group well balanced? Are they lined up straight? Do they look professional? Are they having fun?

PERFORMANCE (JUDGE #2 excluding horsemanship)

The goal of drill and square dance teams is to provide quality entertainment to the spectators. Competition ensures quality.

- 2.5 Horsemanship (JUDGE #1)
 - 2.5.1. Riders in control of horses at all times.
Riders reflect basic horsemanship positions of body, hands, legs and feet.

- 2.6 Variety (JUDGE #2)
 - 2.6.1. Displays a variety of precise maneuvers with minimal repetition.
- 2.7 Difficulty
 - 2.7.1. Shall be judged on, but not limited to, technical merit and speed of maneuvers, precision execution and continuity from one (1) maneuver to another.
- 2.8 Teamwork
 - 2.8.1. Riders are watching each other and working together to ensure correct positioning.
- 2.9 Timing
 - 2.9.1. Consistency in speed of gaits and spacing should be considered.

- 2.10 Entertainment Value
 - 2.10.1 The performance should be entertaining. Pleasant attitudes should be displayed.

Total possible points 250
 (See accompanying score sheet for point distribution for Sections 2.1 through 2.10.)
 (The score sheet / point system are subject to change by a majority vote of participant clubs.)

Subtract possible penalties X

Net Total Points 250 minus (-) X

There will be two (2) judges. One (1) judge will perform the inspection as well as score the horsemanship during the performance. The second judge will score the remaining performance categories.

3.0 A drill team must have at least sixteen (16) or more working horses and not less than two (2) flag horses to perform at the Minnesota State Fair. Flag bearers in the precision drills must have a position in the arena at all times and participate in two (2) or more maneuvers. All other members of the team must participate actively in all maneuvers.

3.1 Small Drill: A small drill team must have ten (10) to fourteen (14) horses to perform at the Minnesota State Fair. One (1) of the horses must be flag bearing. The flag bearing horse is not required to participate in the maneuvers.

3.2 Flag bearers in the square dance need not participate in the maneuvers.

4.0 Drill Master or Caller will present team for inspection and remain nearby, but will not accompany the Judge or Judges while inspecting, nor converse with them unless questioned.

- 5.0 Judges are to inspect the teams as they are in a line-up outside before the dance or drill is to be shown. After he/she has inspected each team, he/she will go to the judging box to view the team's dance or drill performance. The judge is not to converse with anyone and is to be alone at all times with the exception of scribe. The judge shall choose a scribe at his/her discretion. Each judge will give their completed score cards to the ringmaster after each team has completed their performance. The ringmaster will give the score cards to the State Fair Secretary to total points. Scores will be posted only after all teams have performed.
- 6.0 A maximum of ten (10) minutes will be allowed for drill teams, six (6) minutes for small drill teams and five (5) minutes for square dance teams. The drill team shall perform a minimum of eight (8) minutes and a small drill team shall perform for a minimum of four (4) minutes. There shall be no minimum time for square dance teams. Time of the drill starts from the last horse in to the first horse out. The caller shall start and stop the square dance. Penalty for overtime will be five (5) points for each minute or fraction thereof. Penalty for drill teams performing less than eight (8) minutes and small drill teams performing less than four (4) minutes will be five (5) points for each minute or fraction thereof. (Time keeper will keep time but team will continue until drill or dance is complete.)
- 7.0 Judge #1 to begin judging horsemanship as first horse enters arena, to end as last horse exits arena.
- 8.0 Penalties will be assessed if the following situations occur, but the drill / dance does not stop and a reassembly is not required.
- 8.1 Loss of rider shall be five (5) points.
- 8.2 Loss of equipment shall be one (1) to ten (10) points at judge's discretion.
- 8.3 Flag protocol not followed shall be one (1) to ten (10) points at judge's discretion.
- 9.0 One (1) reride will be allowed. Reride to be defined as the need to leave arena, reassemble and start at the beginning of drill or dance. Horse Show Chairman / Ringmaster will decide when the team will re-do the drill / dance. Second ride to be done during the same show. The stop watch / timer to be reset to zero (0). The penalty for a reride shall be thirty (30) points.
- 9.1 A team will be allowed to interrupt/stop their performance, regroup and continue an unlimited number of times. The stop watch/ timer does not reset to zero (0). The penalty for a stop, regroup and continuation will be ten (10) points per occurrence. Other penalties may also apply.
- 9.2 In the event of an injury to a horse or rider, a substitution may be allowed. This substitution is considered a regroup and continuation if the rest of the team remains in the arena and does not start over at the beginning of the drill or dance.
- 11.0 In the square dance, the couple must be dressed as a man and a woman.

BY-LAWS OF WESTERN SADDLE CLUBS ASSOCIATION, INC.

ARTICLE 1 OFFICES

1.1 Offices. The principal office of the corporation shall be located at a location designated from time to time by the Board of Directors. The corporation may have offices at such other places, either within or without the State of Minnesota, as the Board of Directors may from time to time designate.

ARTICLE 2 MEMBERS

2.1 Membership. Membership in the corporation is available to any Western type horse club (a) which has a minimum membership of twelve (12) individual members who pay dues; and (b) which has a slate of officers consisting of a President, Vice President, Secretary and Treasurer. Any such club may apply for membership by completing an "Application for Membership" and any other reasonable requirements set forth by the member delegates.

2.2 Transferability. A member may not voluntarily or involuntarily transfer its membership or any right arising there from.

2.3 Member Delegates. Each member club shall be entitled to two (2) member delegates. Member delegates or their alternates shall have voting power on behalf of each member club resulting in two (2) votes per member club or one (1) vote per member delegate. Delegates or their alternates can vote on behalf of one (1) member club only. Proxy votes shall not be permitted.

2.4 Dues. Each member club shall pay dues in the amount set forth from time to time by the Board of Directors, subject to approval by a majority of the voting member delegates present at any duly called membership meeting.

2.5 Scheduled Meetings. The annual meeting of the members shall be held for the purpose of election of a Board of Directors, election of officers and the transaction of any other business properly coming before it. It shall be held in October of each year at a place designated by the Board of Directors. Special meetings of the members may be called at any time by request of not less than one third (1/3) of the Directors or fifteen (15) percent of the member delegates.

2.6 Notice of Meetings. The Executive Secretary shall give each member delegate written notice of the time and place of each meeting of members, except special meetings, at least forty (40) days prior to the date thereof. Notice of a special meeting shall be given by the Executive Secretary at least ten (10) days prior to the date thereof by written notice.

2.7 Quorum. Fifteen (15) percent of the member delegates shall constitute a quorum for the transaction of business.

ARTICLE 3 BOARD OF DIRECTORS

3.1 General Powers. The business, property, and affairs of the corporation shall be managed by a Board of Directors. The Board shall have all powers that may be exercised by the corporation subject to the will of the membership.

3.2 Nominations. Candidates for the Board of Directors shall be nominated by a Nominating Committee consisting of two (2) directors and three (3) member delegates who are not directors, all of which are appointed by the President. A list of individuals nominated by the Nominating Committee shall be sent to all voting member delegates at least forty (40) days prior to the date of the meeting at which the Board of Directors shall be elected. Nominations shall be also accepted from the floor at such membership meeting. An individual shall not be nominated as a candidate for Director unless (a) such individual has been a member delegate to the corporation during the preceding ten (10) year period, is a member delegate at the time of nomination or be a Director at the time of nomination; and (b) such individual is a member in good standing of a member club in good standing with this corporation.

3.3 Number, Term and Qualification. The corporation shall have eleven (11) Directors. Directors shall be elected at the annual meeting of the members for a term of three (3) years or until their successors are elected and shall qualify. The number of Directors elected each year shall be as equal as possible. No Director shall be elected to more than two (2) consecutive terms. No member club shall have more than two (2) of its individual members as Directors.

3.4 Resignation. Any Director may resign at any time by giving written notice to the Executive Secretary. Such resignation shall take effect at the time specified therein.

3.5 Removal. A Director of the corporation may be removed by vote of two-thirds (2/3) of the member delegates present at a special meeting of the member delegates called for that purpose or at any other meeting of the member delegates held in accordance with these By-Laws.

3.6 Schedule of Meetings. There shall be such regular meetings of the Board of Directors as may from time to time be scheduled by a majority of the whole Board of Directors. Special meetings of the Board of Directors may be called at any time by the Executive Secretary of the corporation, upon written request by the President or not less than one-third (1/3) of the Directors.

3.7 Notice of Meeting. The Executive Secretary shall give to each Director by mail, email or in person, written notice of the time and place of each regular meeting at least ten (10) days prior to the date thereof. Notice of any special meeting shall be given by the Executive Secretary at least ten (10) days prior to the date thereof by written notice to each Director by mail, email or in person. However, a meeting may be held without waiver of notice from or giving notice to any Director while he/she is the armed forces of the United States. Notice in each case shall specify the time and place of the meeting, and, in the case of a special meeting, the purpose or purposes thereof. Any Director may waive notice of any meeting. The attendance of a Director at a meeting shall constitute a waiver of

notice of such meeting except where a Director attends a meeting for the express purpose of objecting to the transaction of any business because the meeting is not lawfully called or convened.

3.8 Place of Meeting. Meetings of the Directors shall be held at such place as may be designated by the Board of Directors.

3.9 Consent to Meetings. The transactions taken at any meetings however called and noticed and wherever and whenever held, shall be as valid as though taken at a meeting duly held in accordance with the other provisions of these By-Laws. If a quorum be present, and if, either before or after the meeting, each of the Directors not present thereat shall give a waiver of notice as provide in Section 11.2. All such waivers of notice shall be made a part of the minutes of said meeting.

3.10 Quorum. A majority of the Board of Directors shall constitute a quorum for the transaction of business.

3.11 Compensation. No Director shall receive any compensation for his services as a Director unless such compensation is authorized by resolution of the Board of Directors and by the member delegates. Nothing herein contained shall be construed to preclude any Director from serving the corporation in any other capacity and receiving compensation therefore.

3.12 Other Meetings. Action may be taken at Director's meetings conducted by conference telephone or other communications equipment by which the Directors may simultaneously hear one another.

3.13 Lifetime Honorary Membership. The corporation may bestow upon an individual a lifetime honorary membership to the Board of Directors. Holders of lifetime honorary memberships shall serve in an advisory capacity only, unless elected to the Board of Directors. No more than five (5) lifetime honorary memberships shall be in existence at any one (1) time.

The individual may serve as a lifetime honorary membership as well as on the actual Board of Directors. An honorary member of the Board of Directors shall not be considered a member of the Board of Directors for any purpose other than as set forth in this paragraph.

ARTICLE 4 OFFICERS

4.1 Number. The officers of the corporation shall be a President, a Vice President, an Executive Secretary, a Treasurer, and such other officers as may from time to time to elected by the member delegates. Provided, however that the Executive Secretary shall be elected by the Board of Directors. Officers (other than the Executive Secretary) must be members of the Board of Directors. The Executive Secretary shall not be a member of the Board of Directors.

4.2 Election, Term of Office and Qualification. At the annual meeting of the member delegates, the member delegates shall elect the officers, except the Executive Secretary. Each such officer shall hold office until the next annual meeting and until his/her successor is elected and has qualified, or until he/she has been removed in

the manner hereinafter provided. The Executive Secretary shall be elected by the Board of Directors and shall hold office for the term designated by the Board of Directors.

4.3 President. The President shall be the chief executive officer of the corporation, shall preside at all meetings of the directors and shall have general control of the business of the corporation. He/she shall be ex-officio a member of all standing committees. He/she may execute and deliver in the name of the corporation any deeds, mortgages, bonds, contracts, or other instruments pertaining to the business of the corporation, and in general shall perform all duties incident to the Office of the President, and such other duties as may from time to time be prescribed by the Board.

4.4 Vice President. The Vice President shall have all of the authority and responsibility of the President in the absence of the President and shall have such other duties as may from time to time be prescribed by the Board.

4.5 Executive Secretary. The Executive Secretary shall (a) keep or cause to be kept in the minute book proper minutes of the proceedings of all meetings of the Board of Directors and Executive Committee; (b) give all required notices; (c) have custody of the corporate records, except records of the Treasurer which shall be in the custody of the Treasurer; (d) notify members of dues owed to the corporation; and (e) perform such other duties as may be assigned to him/her by the Board of Directors.

4.6 Treasurer. The Treasurer shall have charge and custody of all funds of the corporation. He/she shall keep or cause to be kept an accurate account of all receipts and disbursements and shall render accounts to the corporation. He/she shall deposit all monies in the name of the corporation in such banks or depositories as the Directors shall designate. He/she shall have the power to endorse for deposit all instruments received by the corporation. He/she shall disburse funds of the corporation as directed by the Board of Directors. He/she shall perform such other duties as may from time to time be prescribed by the Board of Directors. He/she shall not make any disbursements in excess of three hundred dollars (\$300.00) without prior approval by the Board of Directors.

4.7 Removal and Replacement of Vacancies. Any officer may be removed by at least two thirds (2/3) of the member delegates present at a special meeting of the member delegates called for this purpose or at any other meeting of the member delegates held in accordance with these By-Laws. Such removal shall be without prejudice to the contract rights, if any, of such officer. Any vacancy resulting from such removal or any vacancy resulting from resignation or death may be filled by the Board of Directors at any meeting thereof.

ARTICLE 5 COMMITTEES

5.1 Committees. The President may, from time to time, appoint such committees as it may deem proper, and may prescribe the functions and duties of such committees and the terms of membership of committee members.

5.2 Executive Committee. The Board of Directors may by

resolution establish an Executive Committee of the Board of Directors of the corporation and appoint two (2) or more Directors to serve on such Executive Committee. Only persons who are Directors of the corporation shall be eligible for appointment to the Executive Committee. When a member of the Executive Committee ceases to be a Director of the corporation, such person automatically shall cease to be a member of the Executive Committee of the corporation. Except for the power to amend the Articles of Incorporation and the By-Laws of the corporation, the Executive Committee shall have all of the powers and authority of the Board of Directors of the corporation in the management of the property, business, and affairs of the corporation in the intervals between meetings of the Board of Directors subject always to the direction and control of the Board of Directors. Any action of the Executive Committee shall be reported at the first regular meeting of the Board which follows the action of the Executive Committee.

ARTICLE 6 FISCAL YEAR

6.1 Fiscal Year. The fiscal year of the corporation shall end on the 31st day of December in each year.

ARTICLE 7 NO SEAL

7.1 No Seal. The corporation shall have no seal.

ARTICLE 8 EXECUTION OF CONTRACTS

8.1 Contracts. The Board of Directors, except as otherwise provided in these By-Laws, may authorize any officer or officers, or agent or agents, to enter into any contract, or execute and deliver any instrument in the name of and on behalf of the corporation. Such authority may be general or confined to specific instances. Unless so authorized by the Board of Directors, no officer, agent or employee shall have any power or authority to bind the corporation by any contract or engagement, or to pledge its credit, or to render it liable pecuniary for any purpose or in any amount.

ARTICLE 9 DEPOSITS

9.1 Deposits. All funds of the corporation shall be deposited to the credit of the corporation in such banks, trust companies, or other depositories as the Board of Directors may designate, or as may be designated by any officer or officers or agent or agents of the corporation to whom such power may be delegated by the Board of Directors. For the purpose of such deposit, any person or persons to whom such power is so delegated may endorse, assign and deliver checks, drafts, and other orders for the payment of money which are payable to the order of the corporation

ARTICLE 10 INDEMNIFICATION

10.1 Indemnification. To the full extent permitted by law, the corporation shall indemnify and hold harmless, all officers, Directors, employees and agents of the corporation for all acts performed by them in any good faith attempt to fulfill their duties to the corporation, specifically including all costs and expenses, including attorneys' fees, incurred in any action, claim or demand concerning any such act. This provision shall be construed so as to provide and require the broadest, most complete and extensive scope of the indemnification legally permissible at the time indemnification is sought or provided.

ARTICLE 11 NOTICES

11.1 Notices. All notices required by these By-Laws shall be in writing and shall be given by the Executive Secretary to the Directors or the members entitled thereto at their addresses shown on the records of the corporation if by mail. Notice may also be given in person or by email.

11.2 Waiver of Notice. A Director or member may waive any notice required to be given by these By-Laws, or by the Articles of Incorporation, or by statute, either before or after the time stated therein. Any such waiver in writing signed by the person entitled to notice shall be deemed equivalent to such notice. All waivers shall be filed with the records of the corporation.

ARTICLE 12 COMPENSATION

12.1 Compensation. No individual shall receive a salary or remuneration without prior approval of the Board of Directors and the member delegates of the corporation.

ARTICLE 13 AMENDMENTS

13.1 Amendments. These By-Laws may be amended or repealed and new By-Laws adopted by the affirmative vote of two thirds (2/3) of the total member delegates of the corporation present at any meeting of the members, provided that notice of such proposed amendment, repeal or addition be included in the notice of the meeting held for such purpose and that such notice be given at least forty (40) days prior to the date of the meeting.

ARTICLE 14 RULES OF ORDER

14.1 Rules of Order. Roberts Rules of Order shall govern the conduct of all meetings of the corporation except when in conflict with these By-Laws or the Articles of Incorporation.

GENERAL HORSE INFORMATION

Common Unsoundness and Blemishes

The following unsoundness and blemishes are identified: U – unsoundness, B – blemish.

Head

1. **cataract (U)** – cloudy or opaque appearance of the eye
2. **defective eyes (U)** – impaired vision or blindness
3. **poll evil (U)** – inflamed swelling of poll between ears
4. **roman nose** – faulty conformation
5. **parrot mouth (U)** – lower jaw is shorter than upper jaw
6. **undershot jaw (U)** – upper jaw is shorter than lower jaw

Neck

1. **ewe neck** – faulty conformation

Withers and Shoulders

1. **fistula of withers (U or B)** – inflamed swelling of withers
2. **Sweeney (U)** – atrophy or decrease in size of a single muscle or group of muscles, usually found in shoulder or hip

Front Legs

1. **shoe boil or capped elbow (B)** – soft, flabby swelling at the point of elbow
2. **knee – sprung or buck knee** – over on the knees; faulty conformation
3. **calf-kneed** – back at the knees; faulty conformation
4. **splint (B)** – capsule enlargement usually found inside upper part of front cannon
5. **wind puff (U)** – puffy swellings occurring either side of tendons above fetlock or knee
6. **bowed tendons (U)** – enlarged, stretched flexor tendons behind the cannon bones
7. **ringbone (U)** – bony growth on either or both sides of pastern
8. **side bone (U)** – bony growth above and toward the rear quarter of hoof head
9. **quitter (U)** – fistula of the hoof head
10. **quarter or sand crack (B)** – vertical split in the wall of the hoof
11. **navicular disease (U)** – inflammation of small navicular bone usually inside front foot
12. **founder (U)** – turning up of hoof and rough, deep rings in hoof wall caused by over feeding, sever concussion or disease and abnormal management
13. **contracted feet (B)** – abnormal contraction of heel
14. **thrush (B)** – disease of the frog

Body

1. **heaves (U)** – difficult breathing, lung damage
2. **roaring (U)** – difficult breathing due to obstruction usually in larynx
3. **rupture (U)** – protrusion of internal organs through the wall (hernia) of the body; umbilical or scrotal areas most common
4. **sway back** – faulty conformation
5. **hip down (U)** – fracture of prominence of hip and falling away

Rear Limbs

1. **stifled (U)** – displaced patella of stifle joint
2. **stringhalt (U)** – nervous disorder characterized by excessive jerking of hind leg
3. **thoroughpin (U)** – puffy swelling which appears on upper part of hock and in front of the large tendon
4. **capped hock (B or U)** – enlargement on point of hock depends on stage of development
5. **bog spavin (U)** – meaty, soft swelling occurring on inner front part of hock
6. **bone spavin or jack spavin (U)** – bony growth usually found on inside lower point of hock
7. **curb (U)** – hard swelling back surface of rear cannon about four inches (4") below point of hock
8. **cocked ankle (U)** – usually in hind feet, horse stands bent forward, due to contracted tendons
9. **blood spavin (B)** – swelling of vein usually below seat of bog spavin

HORSE UNSOUNDNESS AND BLEMISHES

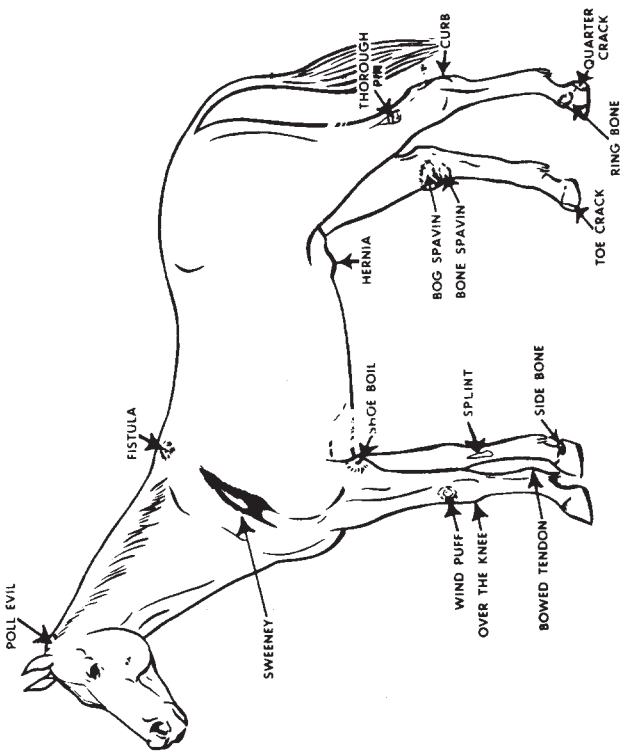

MUSCULAR SYSTEM

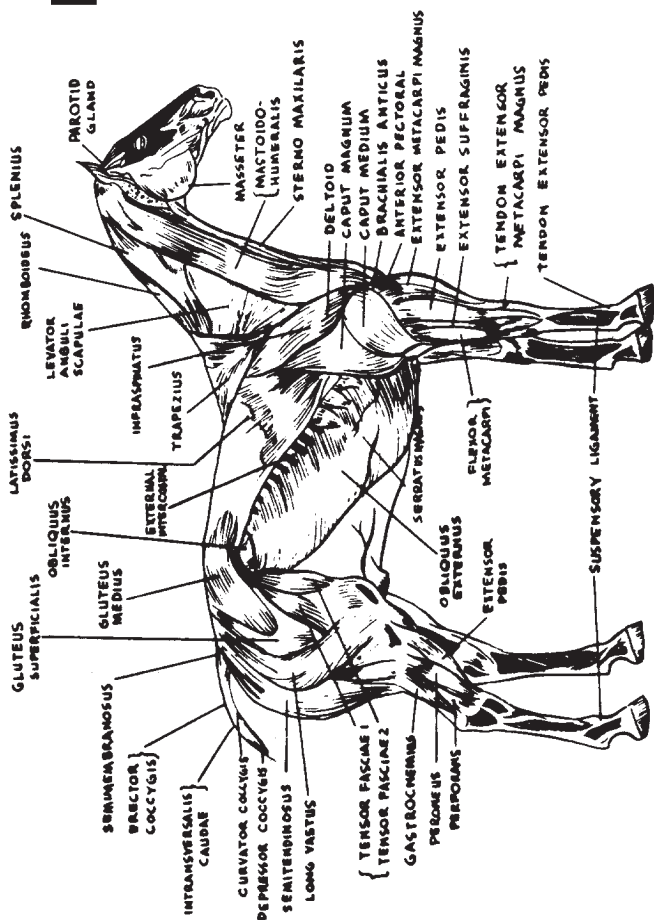

SKELETAL SYSTEM

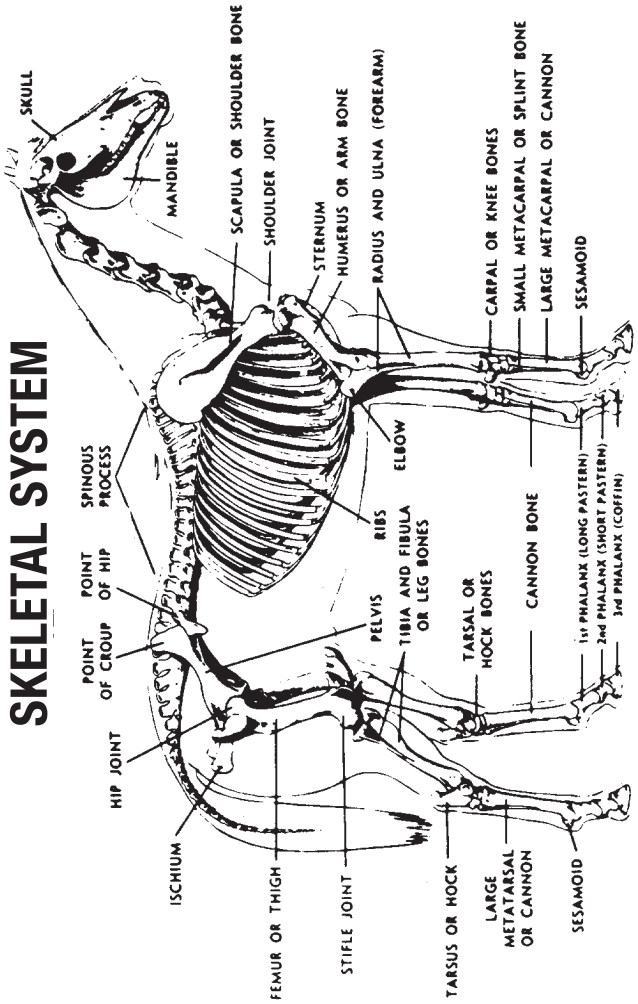

PARTS OF THE HORSE

- | | |
|-----------------------|------------------|
| 1. FOREHEAD | 21. PASTERN |
| 2. FACE | 22. CORONET |
| 3. BRIDGE OF NOSE | 23. FETLOCK |
| 4. NOSTRIL | 24. GIRTH |
| 5. MUZZLE | 25. SHOULDER |
| 6. UPPER LIP | 26. BARREL |
| 7. LOWER LIP | 27. ABDOMEN |
| 8. UNDER LIP | 28. HOOF |
| 9. THROAT LATCH | 29. HOCK |
| 10. POLL | 30. GASKIN |
| 11. CREST | 31. STIFLE |
| 12. NECK | 32. FLANK |
| 13. POINT OF SHOULDER | 33. BUTTOCK |
| 14. CHEST | 34. POINT OF HIP |
| 15. ARM | 35. CROUP |
| 16. ELBOW | 36. LOIN |
| 17. FOREARM | 37. BACK |
| 18. KNEE | 38. WITHERS |
| 19. CANNON | 39. THIGH |
| 20. ANKLE | |

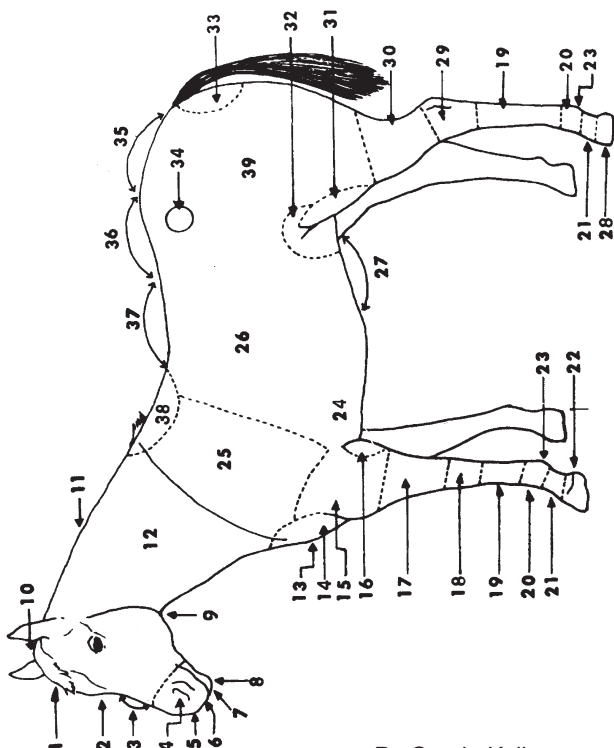

By Carole Kellerman
1957

MARKINGS

Descriptions, both in writing and in drawings, of markings:

Bald: A bald is a very broad blaze. It can extend out and around the eyes and it can extend down to the upper lip and around the nostrils.

Blaze: A blaze is a broader, more open strip.

Coronet: A coronet is any narrow marking around the coronet above the hoof.

Half Pastern: A marking which includes only half the pastern above the coronet.

Pastern: A marking which includes the entire pastern.

Snip: A snip is any marking usually vertical between the two (2) nostrils.

Sock: A sock is a marking which extends around the leg from the coronet half way up the cannon bone, or half way to the knee on the foreleg or half way to the hock on the back leg.

Star: A star is any marking on the forehead.

Star and Strip: A marking on the forehead with a strip to the nasal peak. The strip does not have to be an extension of the star.

Star, Strip and Snip: A marking on the forehead with a narrow extension to the nasal peak and opening up again between the

Stocking: A stocking is a full marking almost to the knee on the foreleg and almost to the hock on the hind leg. It is an extended sock.

Strip: A strip is a narrow vertical marking extending the length of the face.

COLORS

Descriptions of horse colors:

Bay: Body color ranging from tan, through red, to reddish brown; mane and tail black; usually black lower legs.

Black: Body color brown or black with light areas at muzzle, eyes, flank and inside upper leg; mane and tail black, usually black on lower legs.

Blue Roan: More or less uniform mixture of white and black hairs, usually with a few red hairs.

Buckskin: A form of dun with body color yellowish or gold; mane and tail black; usually black on lower legs.

Chestnut: Body color dark red or reddish-brown; mane and tail usually same color as body, but may be flaxen.

Dun: Body color yellowish or gold; mane and tail may be black, brown, red, yellow, white, or mixed; often has dorsal stripe, zebra stripes on legs, and transverse stripe over withers.

Gray: Mixture of white and black hairs; usually born solid colored or almost solid colored and get lighter with age.

Grullo: Body color smoky or mouse-colored (not a mixture of black and white hairs, but with each hair mouse-colored); mane and tail black; usually black on lower legs.

Palomino: Body color a golden yellow; mane and tail white.

Red Dun: A form of dun with body color yellowish or flesh colored; mane and tail red, dorsal stripe.

Red Roan: More or less uniform mixture of white and red hairs.

Sorrel: Body color reddish or copper-red; mane and tail usually same color as body, but may be flaxen.

Additional Horse Terms:

The mark of a knowing horseman is the terms and "horse-talk" which he/she uses frequently and correctly. Learn these terms and use them correctly.

AGE:	MALE:	FEMALE:	MIXED GROUP:
Suckling	Colt	Filly	Foals
Weaning	Colt	Filly	Foals
Yearling	Yearling Colt	Yearly Filly	Yearling Foals or Foals of Last Year
2 Year Old	2 Year Old Colt	2 Year Old Filly	Foals of such and such a year
Mature Breeding Animals	Horse or Stallion	Mare	Horses
Mature Non-Breeding Animals	Gelding	Spayed Mare	Horses

Regardless of actual birth date all horses age one (1) year as of January 1st.



STAR



SNIP



BLAZE



STRIP



STAR, STRIP AND SNIP



STAR AND STRIP

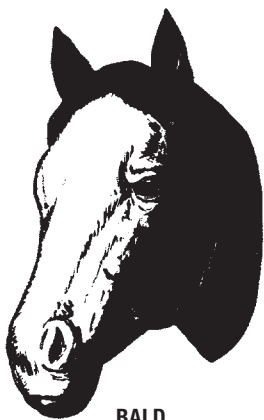

BALD



SOCK



PASTERN



STOCKING



HALF PASTERN

CORONET

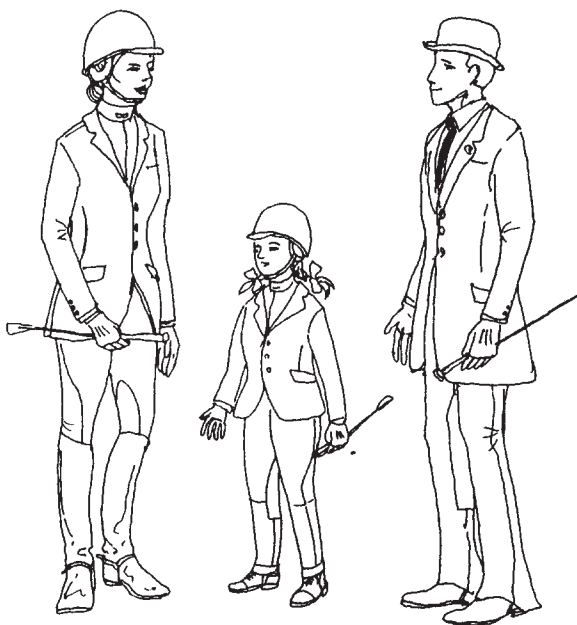

C. HUNT SEAT - Optional child's attire

A. HUNT SEAT - Attire

B. Saddle Suit - informal

*Artwork by
Suzanne Harris*



SAFETY HELMET

A rider may at his discretion wear appropriate protective head-gear with secured harness in any event.

SOME EXAMPLES OF ACCEPTABLE HEAD GEAR

WEYMOUTH BRIDLE

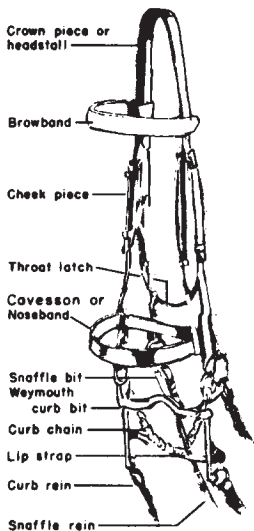

HUNT SEAT BRIDLE

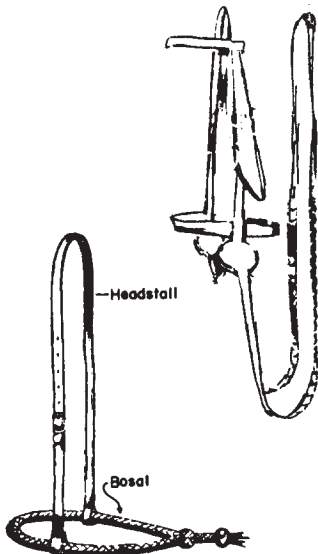

BOSAL HACKAMORE

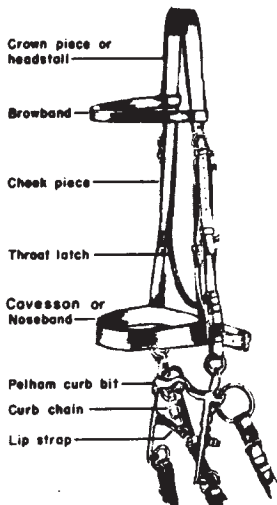

PELHAM BRIDLE

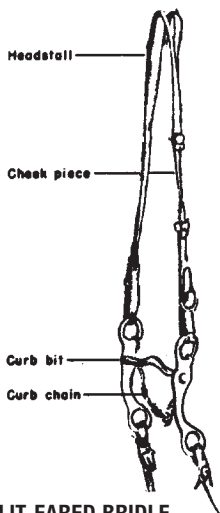

SPLIT-EARED BRIDLE WITH CURB BIT

YOUR SADDLE AND ITS CARE:

1. **If the saddle is very dirty** – and the dirt cannot be wiped off with a dry rag or good leather cleaner, follow these directions. First, with a stiff brush, gently remove as much of the caked mud and dirt as possible, paying special attention to the background stamping on all carved or tooled portions and in cracks. Then wash the saddle thoroughly with a good grade of laundry soap, lukewarm water, and a soft brush. When all grease and dirt has been removed, rinse with clean, lukewarm water until all soap is dissolved. Allow the saddle to dry at normal temperature – never in the sun or under intense heat.

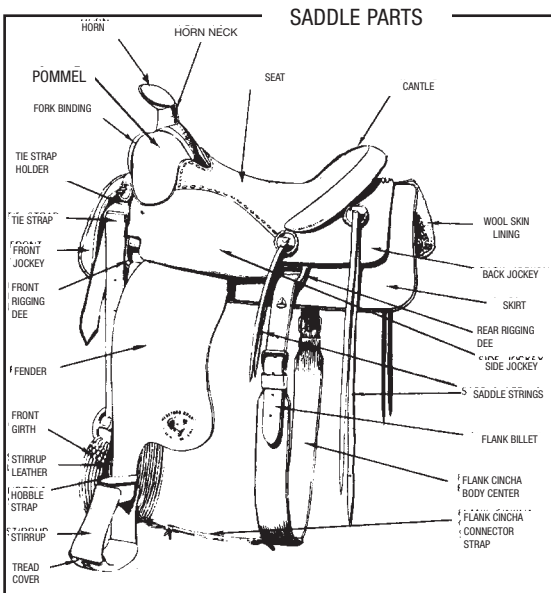

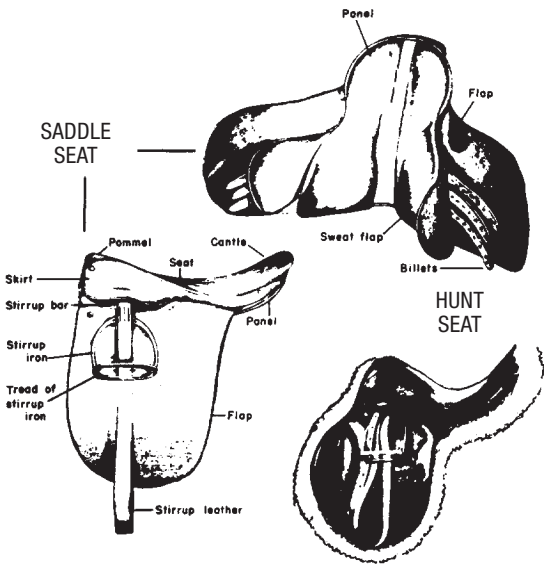

2. **Apply Neat's Foot Oil** – Use a soft cloth and do not saturate the leather. Only apply enough oil to coat the saddle evenly. One (1) coat should be enough if done carefully. Pay special attention to the underside of fenders, latigos, and flank cincha billets as these are exposed to horse sweat and are more prone to rot, than other parts of the saddle. Allow this light coat of oil to seep into the pores of the leather for approximately thirty (30) minutes.
3. **Apply Saddle Soap thoroughly** – Use a damp sponge and apply evenly over the entire saddle. Allow this to dry for two (2) hours – then rub down with a soft cloth. If a glossy finish is desired, a good grade of neutral shoe polish may be used, followed by polishing with a soft rag or brush.
4. **Metal Conchas** – Clean with silver polish before oiling. Wipe off excess silver polish and clean saddle as outlined. Oil, saddle soap or shoe polish may be wiped off conchas with a soft cloth.

A rack like this is sure worth the short time it takes to build it!

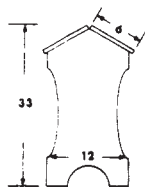

Remember, a saddle which is subject to constant use will require much more maintenance than one (1) which is ridden occasionally. In dry climates, attention must be paid to a saddle more frequently than in normal or moist areas. Leather dries out rapidly when exposed to heat and dust. A good rule to follow, no matter how a saddle is used or where it is; twice a year clean, lightly oil and polish it. This is also an excellent time to check latigos, cinchas and other points where the wear is heavy.

If Your Saddle Gets Wet

Never dry a saddle in the sun or under intense heat. This tends to remove the oil from the leather and allows it to crack. Instead, wipe the saddle as dry as possible with a soft cloth, and then allow it to dry **slowly** in the shade at normal temperature. When the saddle is completely dry, give it a thorough application of saddle soap or a good leather dressing. A light coat of oil on the underside of the leathers, flank cincha and billets helps put the natural moisture back into the leather.

Make certain that the saddle hangs so that all parts are in their proper position when drying. The saddle should be set on a rack or sawhorse, or it may be hung by the horn as shown.

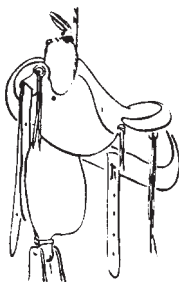

INDEX

Be Sure To Check General Rules in Front of Book

Age Break Down of Riders	17
Balloon Contest	42
Bareback Pickup Race	42
Bat Race	43
Boot Scramble	44
By-Laws of WSCA	63
Championship Show Eligibility	12
Cloverleaf Barrel	43
Costume Class	21
Cow Hide Race	44
Descriptions:	
Common Unsoundness and Blemishes	69
Horse Colors	75
Horse Markings	75
Saddle and its Care	81
Diagrams:	
Chariot Barrel Race	52
Chariot Rescue Race	53
Cloverleaf Barrels	43
Figure 8 Race	45
Four in Line	46
Jumping Figure 8	47
Pole Bending	51
Pole Weaving	51
Reining Pattern 1	30
Reining Pattern 2	31
Reining Pattern 3	32
Reining Pattern 4	33
Reining Pattern 5	34
Relay Race (Team)	54
Ribbon Race	55
Scudda-Ho	57
Western Riding	37
Drill and Square Dance Judging Rules	60
Driving, Open	25
Egg and Spoon Game Class	44
Equipment Race	44
Equitation:	
English Hunt Seat	21
English Open	21
English Saddle Seat	22
Figure Eight Race	44
Flag Race	45
Four in Line	45
General Rules	15
Goat Tying	46
Halter, Open	25
History	9

Horsemanship:	
Bareback Western	24
Western	23
Judges List	3
Jumping Division:	38
Hunter Hack	40
Jumping	40
Working Hunter	38
Jumping Figure 8	47
Key Hole Race	48
Key Race	48
Lead Line – Equitation or Horsemanship	24
Member Clubs List	5
Modified Musical Tires or Sacks	48
Monkey in the Tree	49
Musical Tires or Sacks	48
Package Race	49
Pair Class	
Open	25
Pair Class Divisions	25
Pennant Race – 1 Barrel	49
Pennant Race – 2 Barrel	49
Pictures:	
Attire – Hunt Seat	79
Attire – Saddle Seat	79
Bridles	80
Curb Chains	20
Horse Markings	77
Horse Unsoundness and Blemishes	71
Muscular System	72
Parts of the Horse	74
Leg Markings	78
Positions – Hunt Seat	21
Positions – Saddle Seat	22
Positions – Western Seat	24
Saddle Parts – English	82
Saddle Parts – Western	81
Safety Helmet	79
Skeletal System	73
Western Bridles	80
Whips, Quirts, Crops and Bats	20
Pleasure:	
English Hunt Seat	26
English Saddle Seat	27
Open English	26
Snaffle Bit	27
Western	27
Western Bridle Path	28
Western Non Stock Type	28
Western Pony	28
Western Pony under Saddle	28
Pleasure Driving	25
Pole Bending	50
Pole Bending – Team	50
Pole Weaving	50

Pony Chariot Barrels	52
Pony Chariot Rescue	52
Pony Roadster	28
Pop Race	53
Potato Race	53
Recommendations for Show Committee	13
Reining – General Rules Performance Class	29
Reining – Pattern Instructions	
Pattern 1	30
Pattern 2	30
Pattern 3	31
Pattern 4	33
Pattern 5	34
Reinmanship, Open	26
Relay Race	53
Relay Race – Team	54
Requirements to Join WSCA	11
Rescue Race	55
Ribbon Race	55
Ribbons, Placing	14
Ride a Buck	56
Ring Race	56
Royalty Contest	10
Rulebook Changes	87
Sacks	56
Safety Equipment Regulations	19
Scholarship Program	10
Scoop Shovel Race (or Cowhide Race)	56
Scudda-Ho	57
Showmanship at Halter	35
Speed and Action	57
Speed Dash	58
Tandem Bareback	35
Texas Flag Race	58
Trail Horse Class	35
Trailer Race	59
Walk Trot	36
Water Race	59
Western Riding	36
WSCA Approved Judge Requirements	14
WSCA Committee Chairpersons	2
WSCA Current Officers	1
WSCA List of Judges	3
WSCA Mission Statement	10
WSCA Saddle Club Membership List	5
WSCA Show Approval	12

Rulebook Changes

Rulebook Changes – Page 12
WSCA Approved Show – Page 13
General Rules – Page 17 – Rule 20
General Rules – Page 18 – Rule 24
Approved Safety Equipment - Page 19 – Rule 1
Equitation English Open - Page 21
Equitation English Hunt Seat - Page 21
Pleasure Open English - Page 26
Pleasure English Hunt Seat - Page 26
Pleasure Western – Page 27
Pleasure Western Non Stock Type – Page 28
Pleasure Western Pony Pleasure – Page 28
Cloverleaf Barrel Race - Page 43
Drills & Squares - Page 61 – Rule 2.6
Drills & Squares - Page 61 – Rule 2.10
Drills & Squares - Page 61 – Rule 3.0
Drills & Squares - Page 61 – Rule 3.1
Drills & Squares - Page 61 – Rule 3.2
Drills & Squares - Page 62 – Rule 6.0
Drills & Squares - Page 62 – Rule 7.0
Drills & Squares - Page 62 – Rule 8.0
Drills & Squares - Page 62 – Rule 9.0
Drills & Squares - Page 62 – Rule 11.0

